

The Harper logo is a red rounded rectangle with a white border. Inside, the word "HARPER" is written in large, white, bold, sans-serif capital letters. Below the name, "Est. 1900" is written in a smaller, white, italicized serif font, flanked by horizontal lines.

HARPER

— Est. 1900 —

A large, wide-brush broom with a wooden handle and a black metal frame. The broom head is white with red end caps and red bristles. It is shown sweeping debris like leaves and pine needles on a grey stone patio. A person's legs in khaki pants and brown shoes are visible in the background.

PRODUCT GUIDE | 2018



WHAT WE DO

HARPER Brush has been making brushes and brooms in America since 1900. Based in the heart of America, HARPER's Fairfield facility in Iowa uses **quality components** to build products that **stand the test of time**.

Known for their trademark painted ends on their best-in-class push brooms, HARPER products are easily identified by people who know quality craftsmanship. HARPER has the heritage and quality to provide brooms and brushes for heavy duty users across the globe – for durability YOU can rely on, choose the painted ends!

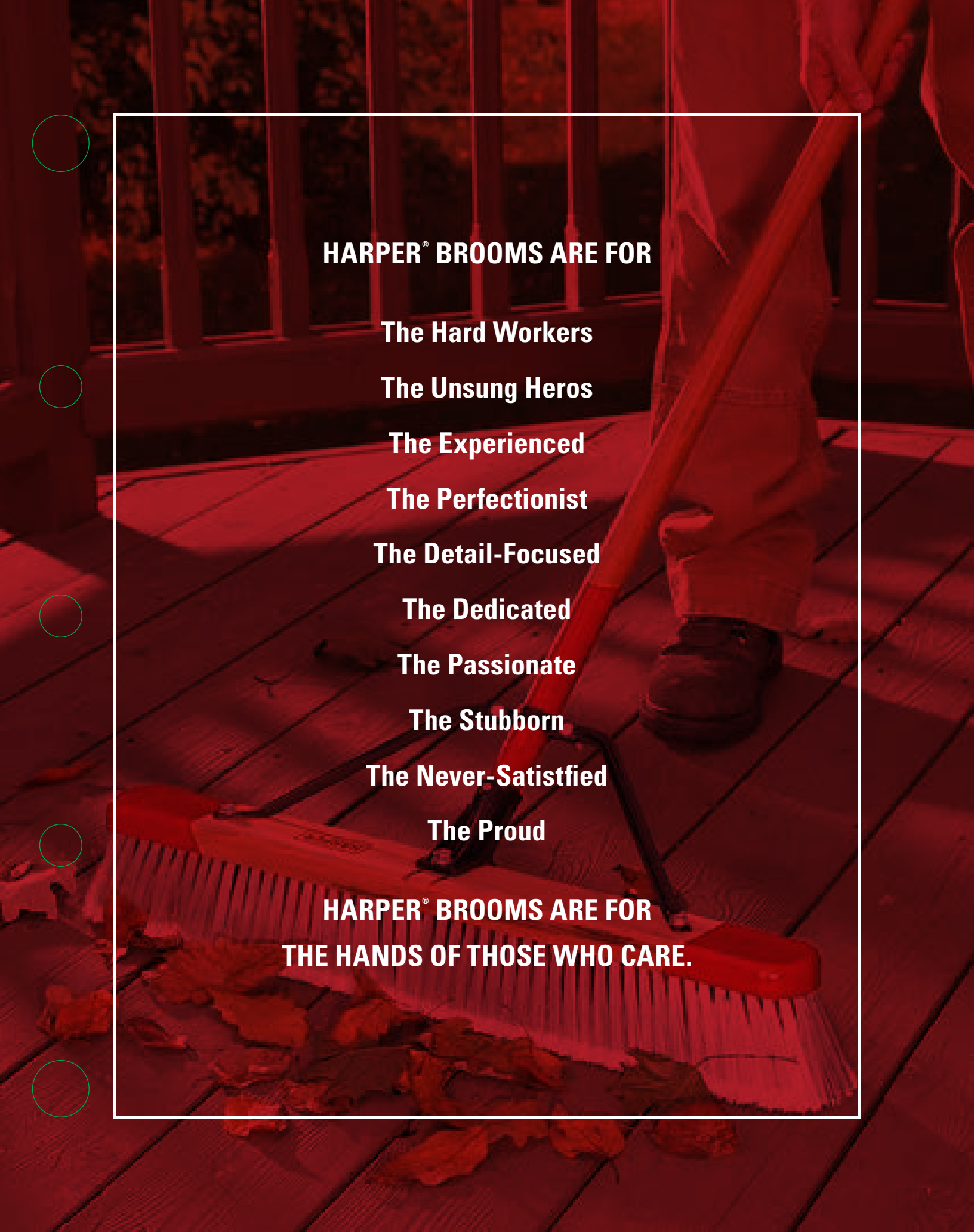
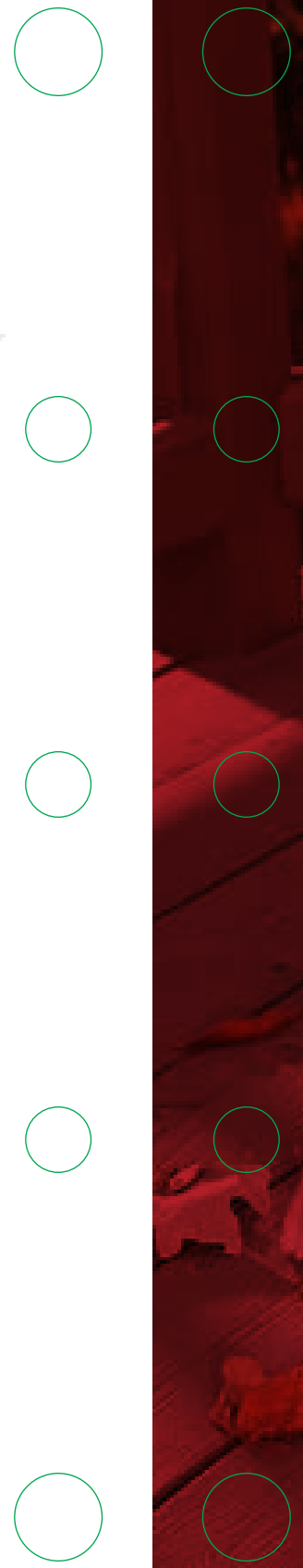

HARPER® BROOMS ARE FOR

The Hard Workers

The Unsung Heros

The Experienced

The Perfectionist

The Detail-Focused

The Dedicated

The Passionate

The Stubborn

The Never-Satisfied

The Proud

**HARPER® BROOMS ARE FOR
THE HANDS OF THOSE WHO CARE.**



PUSH BROOMS
 Best-In-Class Premium Red-End 7-12
 Unbreakable 13-16
 Contractor Grade. 17-20
 Threaded Block. 21-29

BROOMS
 Corn Brooms 32-33
 Angle Brooms. 34-35
 Upright Brooms. 36-37

WASH BRUSHES
 All Purpose Specialty Brushes. 38-42
 Wash Brushes 43

SQUEEGEES/MOPS
 Floor Squeegees 44-47
 Wet Mops 48-49
 Mop Buckets 50
 Window Squeegees 51
 Sponge Mops. 52
 Dust Mops. 53

DECK, SCRUB AND MASONRY BRUSHES
 Deck Brushes. 55
 Masonry Brushes 56-57

UTILITY BRUSHES. 58-60

COUNTER BRUSHES. 61-63

VEHICLE AND MISCELLANEOUS BRUSHES. . . . 64-65

DUST & DEBRIS PANS 66-68

HANDLES 69-73

REPLACEMENT PARTS 74-75

MERCHANDISERS 76-77

INDEX 78

Our extensive line of high-quality, heavy-duty cleaning tools meet the needs of any customer. Whether the cleaning project is light dust or gravel, liquids or sludge, HARPER® has the right tool to tackle the job.

DURABILITY PROS RELY ON

Tough, reliable and hardworking, every product we manufacture is "Pro-Perfected". Manufactured in the USA, our products have the features that set the bar high when it comes to quality and durability. Successfully combining old-fashioned quality with 21st century innovation, we've taken full advantage of technological advances to streamline business operations and enhance our products while continuing to focus on how it all began—an American reputation steeped in quality and integrity to create Durability Pros Rely On.



Alphonso K. "A.K." Harper, 1899



Harper Brush Works, Inc.,
Fairfield, Iowa, 1946



Harper Brush Works, Inc.,
Fairfield, Iowa, Today

PUSH BROOMS — BEST-IN-CLASS PREMIUM RED-END

Instantly identified by the trademark red-painted ends, HARPER push brooms are made using North American furniture-grade premium hardwood maple blocks to prevent cracking and warpage, and provide the best surface contact for better cleaning. Premium-quality fiber is specifically selected for every cleaning need. Designed and engineered to sweep away debris with one push, makes cleanup easier and more efficient.

 **ENGINEERED FOR PROFESSIONAL DAILY USE**

HARPER
Est. 1900

PUSH BROOMS — BEST-IN-CLASS PREMIUM RED-END

INDOOR • DRY DEBRIS



- Hardwood maple block
- Fine, split-tip Polystyrene fibers designed for fine, dry dust and debris such as sand, saw dust, wood shavings and pet hair
- Best for indoor use on dry, smooth concrete, tile or wood surfaces
- Ideal for warehouses, body shops, offices, hospitals, garages
- Slotted block will accept a HARPER bolt-on connector
- Assembled push brooms come with a 1-1/8" x 60" wood handle with bolt-on connector and steel brace



Part No	Description	Qty/Master Carton	Package
H2218	18" Indoor push broom head	4	Label
221812	18" Indoor push broom head	6	Corrugate Sleeve
2218A	18" Assembled indoor push broom with steel brace	4	Label
2224	24" Indoor push broom head	4	Label
222412	24" Indoor push broom head	6	Corrugate Sleeve
2224A	24" Assembled indoor push broom with steel brace	4	Label
2224P1	24" Indoor push broom, easy to ship, ready to assemble with brace and handle – internet solution	1	Box
2236	36" Indoor push broom head	3	Label
223612	36" Indoor push broom head	6	Corrugate Sleeve



HARPER

800.393.1846 | WWW.HARPERBRUSH.COM

DURABILITY PROS RELY ON

★ PUSH BROOMS — BEST-IN-CLASS PREMIUM RED-END



INDOOR • HIGH-TEMPERATURE DEBRIS



- Hardwood maple block
- Natural, heat-resistant Tampico bristles
- Sweeps metal shavings, filings and industrial chemicals
- Ideal for welding shops, foundries and high-temperature surfaces or debris
- Slotted block will accept a HARPER bolt-on connector
- Assembled push brooms come with a 1-1/8" x 60" wood handle with bolt-on connector and steel brace

Part No	Description	Qty/Master Carton	Package
3224	24" Tampico push broom head	4	Label
322412	24" Tampico push broom head	6	Corrugate Sleeve
3224A	24" Assembled Tampico push broom with steel brace	4	Label
3236	36" Tampico push broom head	3	Label
323612	36" Tampico push broom head	6	Corrugate Sleeve



- Hardwood maple block
- Natural, heat-resistant Tampico with two rows of steel wire
- Sweeps tough dirt, metal shavings, filings and hot debris
- Use indoors in dry conditions
- Ideal for welding shops, foundries, factories and high-temperature surfaces or debris
- Slotted block will accept a HARPER bolt-on connector
- Assembled push brooms come with a 1-1/8" x 60" wood handle with bolt-on connector and steel brace

Part No	Description	Qty/Master Carton	Package
5424	24" Tampico and steel push broom head	4	Label
542412	24" Tampico and steel push broom head	6	Corrugate Sleeve
5424A	24" Assembled Tampico and steel push broom with steel brace	4	Label



★ PUSH BROOMS — BEST-IN-CLASS PREMIUM RED-END

INDOOR/OUTDOOR • DRY DEBRIS



- Hardwood maple block
- Fine, split-tip Polystyrene bristles with two rows of steel wire
- Sweeps fine dust and heavier debris such as drywall dust, nails and wood shavings
- Use indoors or outdoors on dry surfaces; not for finished floors
- Ideal for new construction, remodeling and textured surfaces
- Slotted block will accept a HARPER bolt-on connector
- Assembled push brooms come with a 1-1/8" x 60" wood handle with bolt-on connector and steel brace

Part No	Description	Qty/Master Carton	Package
H3024	24" Indoor/outdoor steel center push broom head	4	Label
302412	24" Indoor/outdoor steel center push broom head	6	Corrugate Sleeve
3024A	24" Assembled indoor/outdoor steel center push broom	4	Label



- Hardwood maple block
- Dual Polystyrene bristles for maximum clean-up
- Sweeps everything from dust to mid-weight debris, dirt, leaves and gravel
- Use indoors or outdoors on all dry surfaces, dry debris
- Ideal for garages, driveways and clean-up on concrete or wood
- Slotted block will accept a HARPER bolt-on connector
- Assembled push brooms come with a 1-1/8" x 60" wood handle with bolt-on connector and steel brace

Part No	Description	Qty/Master Carton	Package
3418	18" All-purpose dry debris push broom head	4	Label
341812	18" All-purpose dry debris push broom head	6	Corrugate Sleeve
3418A	18" Assembled all-purpose dry debris push broom with steel brace	4	Label
3424	24" All-purpose dry debris push broom head	4	Label
342412	24" All-purpose dry debris push broom head	6	Corrugate Sleeve
3424A	24" Assembled all-purpose dry debris push broom with steel brace	4	Label
3424P1	24" All-purpose dry debris push broom, easy to ship, ready to assemble with brace and handle – internet solution	1	Box
H3430	30" All-purpose dry debris push broom head	4	Label
3430A	30" Assembled all-purpose dry debris push broom with steel brace	4	Label
3436	36" All-purpose dry debris push broom head	3	Label
343612	36" All-purpose dry debris push broom head	6	Corrugate Sleeve



★ PUSH BROOMS — BEST-IN-CLASS PREMIUM RED-END

INDOOR/OUTDOOR • WET AND DRY DEBRIS



- Hardwood maple block
- Semi-stiff Polystyrene bristles for all surfaces
- Sweeps oil dry, dirt, soil, mulch, grass and wood
- Use indoors or outdoors in wet or dry conditions
- Ideal for seasonal clean-up, job sites, plants, grain elevators and patios
- Slotted block will accept a HARPER bolt-on connector
- Assembled push brooms come with a 1-1/8" x 60" wood handle with bolt-on connector and steel brace



Part No	Description	Qty/Master Carton	Package
7318	18" All-purpose wet & dry clean-up push broom head	4	Label
731812	18" All-purpose wet & dry clean-up push broom head	6	Corrugate Sleeve
7318A	18" Assembled all-purpose wet & dry clean-up push broom with steel brace	4	Label
7324	24" All-purpose wet & dry clean-up push broom head	4	Label
732412	24" All-purpose wet & dry clean-up push broom head	6	Corrugate Sleeve
7324A	24" Assembled all-purpose wet & dry clean-up push broom with steel brace	4	Label
7324P1	24" All-purpose wet & dry clean-up push broom, easy to ship, ready to assemble with brace and handle – internet solution	1	Box
7330	30" All-purpose wet & dry clean-up push broom head	4	Label
H7336	36" All-purpose wet & dry clean-up push broom head	3	Label

OUTDOOR • DRY DEBRIS

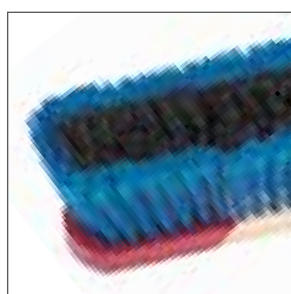

- Hardwood maple block
- Stiff interior bristles and fine, split-tip Polystyrene border bristles
- Sweeps everything from dust to mid-weight debris, gravel, nails and metal shavings
- Use outdoors in dry conditions
- Ideal for garages, driveways, concrete surfaces or streets
- Slotted block will accept a HARPER bolt-on connector
- Assembled push brooms come with a 1-1/8" x 60" wood handle with bolt-on connector and steel brace



Part No	Description	Qty/Master Carton	Package
6724A	24" Assembled outdoor dual bristle push broom with steel brace head	4	Label
6724P1	24" Outdoor dual bristle push broom, easy to ship, ready to assemble with brace and handle – internet solution	1	Box



★ PUSH BROOMS — BEST-IN-CLASS PREMIUM RED-END

OUTDOOR • WET AND DRY DEBRIS



- Hardwood maple block
- Stiff sweeping synthetic bristles
- Sweeps heavy mulch, gravel, oil dry, dirt and soil
- Use outdoors on rough wet or dry surfaces
- Ideal for job sites, seasonal clean-up, landscaping, plants and grain elevators
- Slotted block will accept a HARPER bolt-on connector
- Assembled push brooms come with a 1-1/8" x 60" wood handle with bolt-on connector and steel brace



Part No	Description	Qty/Master Carton	Package
H7918	18" Rough-surface push broom head	4	Label
791812	18" Rough-surface push broom head	6	Corrugate Sleeve
7918A	18" Assembled rough-surface push broom with steel brace	4	Label
7924	24" Rough-surface push broom head	4	Label
792412	24" Rough-surface push broom head	6	Corrugate Sleeve
7924A	24" Assembled rough-surface push broom with steel brace	4	Label
7924AS	24" Assembled rough-surface push broom with steel brace and metal scraper	4	Label
7924P1	24" Rough-surface push broom, easy to ship, ready to assemble with brace and handle – internet solution	1	Box



★ PUSH BROOMS — BEST-IN-CLASS PREMIUM RED-END

OUTDOOR • HEAVY WET AND DRY DEBRIS

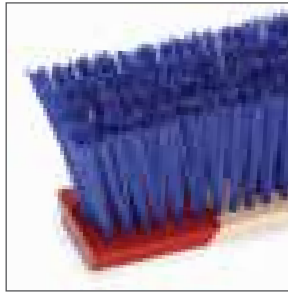

- Hardwood maple block
- 4-1/8" stiff sweeping synthetic bristles
- Sweeps heavy gravel, wet grass, mulch and heavy dirt
- Use outdoors on rough wet or dry surfaces
- Ideal for street departments, landscaping, roofing job sites and heavy farm use
- Slotted block will accept a HARPER bolt-on connector
- Assembled push brooms come with a 1-1/8" x 60" wood handle with bolt-on connector and steel brace

9418



Part No	Description	Qty/Master Carton	Package
9418	18" Rough-surface street debris push broom	4	Label
941812	18" Rough-surface street debris push broom	6	Corrugate Sleeve
9418A	18" Assembled rough-surface street debris push broom with steel brace	4	Label
9424	24" Rough-surface street debris push broom	4	Label
942412	24" Rough-surface street debris push broom	6	Corrugate Sleeve
9424A	24" Assembled rough-surface street debris push broom with steel brace	4	Label
9424AS	24" Assembled rough-surface street debris push broom with steel brace and scraper	3	Label



- Hardwood maple block
- 4-1/8" stiff sweeping synthetic bristles
- Sweeps heavy gravel, mulch and heavy dirt
- Use outdoors on rough wet or dry surfaces
- Ideal for street departments, landscaping, roofing and job sites
- Slotted block will accept a HARPER bolt-on connector
- Assembled push brooms come with a 1-1/8" x 60" wood handle with bolt-on connector and steel brace

9616



Part No	Description	Qty/Master Carton	Package
9616	16" Safety orange street debris push broom head	4	Label
9618	18" Safety orange street debris push broom head	4	Label



PUSH BROOMS — UNBREAKABLE

HARPER'S® Unbreakable push brooms feature a tough connector that takes an impact better than other connector types that can bend, twist or break. The patented design is light weight and absorbs shock to greatly reduce back and wrist strain, allowing for quicker and easier clean up. Just like all other HARPER cleaning tools, there's a bristle type to match any condition or surface – indoors or outdoors, wet or dry, rough or smooth.

INDOOR • DRY DEBRIS



- Durable, lacquered, pre-drilled block will accept an Unbreakable Connector or Contractor Grade Bolt-On Connector
- Soft, split-tip synthetic bristles
- Sweeps fine, dry dust and debris such as sand, saw dust, wood shavings, and pet hair
- Use indoors on dry, smooth surfaces
- Ideal for warehouses, body shops, offices, schools, hospitals and garages
- Assembled push brooms come with a 1-1/8" x 60" wood handle with an Unbreakable Connector and comfort end grip

1425A

142512



Part No	Description	Qty/Master Carton	Package
142112	18" Indoor push broom head	6	Corrugate Sleeve
1421A	18" Assembled indoor push broom with Unbreakable Connector	4	Label
142512	24" Indoor push broom head	6	Corrugate Sleeve
1425P12	24" Indoor push broom head, resin garage block	6	Corrugate Sleeve
1425	24" Indoor push broom, side-clipped with 60" wood handle and Unbreakable Connector	4	Sleeve
1425A	24" Assembled indoor push broom with Unbreakable Connector	4	Label
1425P1	24" indoor push broom, easy to ship, ready to assemble with connector and handle – internet solution	1	Box



PUSH BROOMS — UNBREAKABLE

INDOOR • HIGH-TEMPERATURE DEBRIS



- Durable, lacquered, pre-drilled block will accept an Unbreakable Connector or Contractor Grade Bolt-On Connector
- Natural, heat-resistant Tampico bristles
- Sweeps metal shavings, filings and industrial chemicals
- Use indoors on high-temperature surfaces
- Ideal for welding shops, foundries and high-temperature surfaces or debris

Part No	Description	Qty/Master Carton	Package
143812	18" Tampico push broom head	6	Corrugate Sleeve
143912	24" Tampico push broom head	6	Corrugate Sleeve

143912



INDOOR/OUTDOOR • DRY DEBRIS



- Durable, lacquered, pre-drilled block will accept an Unbreakable Connector or Contractor Grade Bolt-On Connector
- Dual bristles for maximum cleaning power
- Stiff interior bristles dislodge stuck on dirt and debris
- Fine, split-tip outer bristles pick up small particles
- Sweeps everything from dust to mid-weight debris, dirt, leaves and gravel
- Use indoors or outdoors on dry surfaces
- Ideal for workshops, basements, garage floors, patios, sidewalks and decks
- Assembled push brooms come with a 1-1/8" x 60" wood handle with an Unbreakable Connector and comfort end grip

Part No	Description	Qty/Master Carton	Package
142212	18" All-purpose dry debris push broom head	6	Corrugate Sleeve
1422A	18" Assembled all-purpose dry debris push broom with Unbreakable Connector	4	Label
142612	24" All-purpose dry debris push broom head	6	Corrugate Sleeve
1426P12	24" All-purpose dry debris push broom head, resin garage block	6	Corrugate Sleeve
1426	24" All-purpose dry debris push broom, side-clipped with 60" wood handle and Unbreakable Connector	4	Sleeve
1426A	24" Assembled all-purpose dry debris push broom with Unbreakable Connector	4	Label
1426ASC	24" Assembled all-purpose dry debris push broom with Unbreakable Connector and plastic scraper	4	Label
1426P1	24" All-purpose dry debris push broom, easy to ship, ready to assemble with Unbreakable Connector and handle – internet solution	1	Box

1426A

1426ASC

142612



PUSH BROOMS — UNBREAKABLE

INDOOR/OUTDOOR • WET AND DRY DEBRIS



- Durable, lacquered, pre-drilled block will accept an Unbreakable Connector or Contractor Grade Bolt-On Connector
- Semi-stiff bristles for all surfaces
- Sweeps everything from mid-weight to heavy dirt, leaves, gravel and mulch
- Use indoors or outdoors on wet or dry surfaces
- Ideal for garage floors, patios, sidewalks and decks
- Assembled push brooms come with a 1-1/8" x 60" wood handle and Unbreakable Connector and comfort end grip

Part No	Description	Qty/Master Carton	Package
213A	18" Assembled multi-use wet & dry clean up push broom with Unbreakable Connector	4	Label
214A	24" Assembled multi-use wet & dry clean up push broom with Unbreakable Connector	4	Label
214SC	24" Multi-use wet & dry clean up push broom, side-clipped with 60" wood handle and Unbreakable Connector	4	Sleeve

214A



OUTDOOR • WET AND DRY DEBRIS



- Durable, lacquered, pre-drilled block will accept an Unbreakable Connector or Contractor Grade Bolt-On Connector
- Dual bristles for maximum cleaning power
- Super stiff interior bristles dislodge stuck on dirt and debris
- Fine outer bristles pick up small particles
- Sweeps dirt, soil, mulch, wet grass, wood and Oil-Dri®
- Use outdoors on rough wet or dry surfaces
- Ideal for garage floors, driveways, patios, sidewalks, asphalt, and barns
- Assembled push brooms come with a 1-1/8" x 60" wood handle and Unbreakable Connector and comfort end grip

Part No	Description	Qty/Master Carton	Package
142312	18" All-purpose wet & dry clean up push broom head	6	Corrugate Sleeve
1423A	18" Assembled all-purpose wet & dry clean up push broom with Unbreakable Connector	4	Label
143412	24" All-purpose wet & dry clean up push broom head	6	Corrugate Sleeve
1434P12	24" All-purpose wet & dry clean up push broom head, resin garage block	6	Corrugate Sleeve
1434	24" All-purpose wet & dry clean up push broom, side-clipped with 60" wood handle with Unbreakable Connector	4	Sleeve
1434A	24" Assembled all-purpose wet & dry clean up push broom with Unbreakable Connector	4	Label
1434ASC	24" Assembled all-purpose wet & dry clean up push broom with Unbreakable Connector and metal scraper	4	Label
1434P1	24" All-Purpose wet & dry clean up push broom, easy to ship, ready to assemble with Unbreakable Connector and handle – internet solution	1	Box

1434A

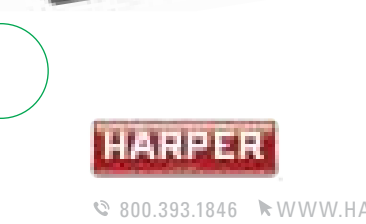

PUSH BROOMS — UNBREAKABLE

OUTDOOR • HEAVY WET AND DRY DEBRIS



- Durable, lacquered, pre-drilled block will accept an Unbreakable Connector or Contractor Grade Bolt-On Connector
- Long 4" stiff sweeping synthetic bristles push heavy loads and large debris
- Sweeps heavy debris, gravel, wet grass, rocks, mulch and dirt
- Use outdoors on rough wet or dry surfaces
- Ideal for job sites, wooden floors, concrete, asphalt and parking lots
- Assembled push brooms come with a 1-1/8" x 60" wood handle and Unbreakable Connector and comfort end grip

Part No	Description	Qty/Master Carton	Package
143712	18" Outdoor heavy-duty rough surface push broom head	6	Corrugate Sleeve
1437A	18" Assembled outdoor heavy-duty rough surface push broom with Unbreakable Connector	4	Label
143512	24" Outdoor heavy-duty rough surface push broom head	6	Corrugate Sleeve
1435P12	24" Outdoor heavy-duty rough surface push broom head, resin garage block	6	Corrugate Sleeve
1435	24" Outdoor heavy-duty rough surface push broom, side-clipped with 60" wood handle with Unbreakable Connector	4	Sleeve
1435A	24" Assembled outdoor heavy-duty rough surface push broom with Unbreakable Connector	4	Label
1435ASC	24" Assembled outdoor heavy-duty rough surface push broom with Unbreakable Connector and metal scraper	4	Label
1435P1	24" Outdoor heavy-duty rough surface push broom, easy to ship, ready to assemble with Unbreakable Connector and handle – internet solution	1	Box



- Durable, lacquered, pre-drilled block will accept an Unbreakable Connector or Contractor Grade Bolt-On Connector
- Natural, stiff Palmyra bristles for tough cleaning of heavy dirt and debris
- Long 4" trim length for sweeping power
- Sweeps heavy debris, gravel, wet grass, rocks, mulch and dirt
- Use outdoors on rough wet or dry surfaces
- Ideal for job sites, wooden floors, concrete, asphalt and parking lots

Part No	Description	Qty/Master Carton	Package
143612	24" Palmyra push broom head	6	Corrugate Sleeve
1436P12	24" Palmyra push broom head, resin garage block	6	Corrugate Sleeve



PUSH BROOMS — CONTRACTOR GRADE

HARPER'S® Contractor-Grade Bolt-On Connector push brooms are ideal for cleanup around the garage, basement, barn and warehouse. Featuring a lacquered, pre-drilled block that accepts a strong, heavy-duty bolt-on connector and steel brace for reinforcement, they can sweep everything from fine, dry dust to mid- to heavy-weight debris. Select from a variety of bristle types for cleaning wet or dry material on smooth or rough surfaces, whether it's indoors or outdoors.

INDOOR • DRY DEBRIS



- Durable, lacquered, pre-drilled block will accept a Contractor Grade Bolt-On Connector or Unbreakable Connector
- Soft, split-tip synthetic bristles
- Sweeps fine, dry dust and debris such as sand, saw dust, wood shavings, and pet hair
- Use indoors on dry, smooth surfaces
- Ideal for warehouses, body shops, offices, schools, hospitals and garages
- Assembled push brooms come with a 1-1/8" x 60" wood handle with bolt-on connector and steel brace

Part No	Description	Qty/Master Carton	Package
142512	24" Indoor push broom head	6	Corrugate Sleeve
1425AJ	24" Assembled indoor push broom with steel brace	4	Label



INDOOR/OUTDOOR • DRY DEBRIS



- Durable, lacquered, pre-drilled block will accept a Contractor Grade Bolt-On Connector or Unbreakable Connector
- Dual bristles for maximum cleaning power
- Stiff interior bristles dislodge stuck on dirt and debris
- Fine, split-tip outer bristles pick up small particles
- Sweeps everything from dust to mid-weight debris, dirt, leaves and gravel
- Use indoors or outdoors on dry surfaces
- Ideal for workshops, basements, garage floors, patios, sidewalks and decks
- Assembled push brooms come with a 1-1/8" x 60" wood handle with bolt-on connector and steel brace

Part No	Description	Qty/Master Carton	Package
142612	24" All-purpose dry debris push broom head	6	Corrugate Sleeve
1426AJ	24" Assembled all-purpose dry debris push broom with steel brace	4	Label



PUSH BROOMS — CONTRACTOR GRADE



INDOOR/OUTDOOR • WET AND DRY DEBRIS



- Durable, lacquered, pre-drilled block will accept a Contractor Grade Bolt-On Connector or Unbreakable Connector
- Semi-stiff bristles for all surfaces
- Sweeps everything from mid-weight to heavy dirt, leaves, gravel and mulch
- Use indoors or outdoors on wet or dry surfaces
- Ideal for garage floors, patios, sidewalks and decks
- Assembled push brooms come with a 1-1/8" x 60" wood handle with bolt-on connector and steel brace



214AJ

Part No	Description	Qty/Master Carton	Package
214AJ	24" Assembled multi-use wet & dry clean-up push broom with steel brace	4	Label



PUSH BROOMS — CONTRACTOR GRADE

OUTDOOR • WET AND DRY DEBRIS



- Durable, lacquered, pre-drilled block will accept a Contractor Grade Bolt-On Connector or Unbreakable Connector
- Dual bristles for maximum cleaning power
- Super stiff interior bristles dislodge stuck on dirt and debris
- Fine outer bristles pick up small particles
- Sweeps dirt, soil, mulch, wet grass and wood and Oil-Dri®
- Use outdoors on rough wet or dry surfaces
- Assembled push brooms come with a 1-1/8" x 60" wood handle with bolt-on connector and steel brace



1434AJ



1434ASQ

Part No	Description	Qty/Master Carton	Package
143412	24" All-purpose wet & dry clean up push broom head	6	Corrugate Sleeve
1434AJ	24" Assembled all-purpose wet & dry clean up push broom with steel brace	4	Label
1434ASQ	24" Assembled all-purpose wet & dry clean up push broom with rubber squeegee	4	Label



PUSH BROOMS — CONTRACTOR GRADE

OUTDOOR • HEAVY WET AND DRY DEBRIS



- Durable, lacquered, pre-drilled block will accept a Contractor Grade Bolt-On Connector or Unbreakable Connector
- Long 4" stiff sweeping synthetic bristles
- Sweeps heavy debris, gravel, wet grass, rocks, mulch and dirt
- Use outdoors on rough wet or dry surfaces
- Ideal for job sites, wooden floors, concrete, asphalt and parking lots
- Assembled push brooms come with a 1-1/8" x 60" wood handle bolt-on connector and steel brace

Part No	Description	Qty/Master Carton	Package
143512	24" Outdoor heavy-duty rough surface push broom head	6	Corrugate Sleeve
1435AJ	24" Assembled outdoor heavy-duty rough surface push broom with steel brace	4	Label



- Durable, lacquered, pre-drilled block will accept a Contractor Grade Bolt-On Connector or Unbreakable Connector
- Natural, stiff Palmyra bristles for tough cleaning of heavy dirt and debris
- Long 4" trim length for sweeping power
- Sweeps heavy debris, gravel, wet grass, rocks, mulch and dirt
- Use outdoors on rough wet or dry surfaces
- Ideal for job sites, wooden floors, concrete, asphalt and parking lots

Part No	Description	Qty/Master Carton	Package
143612	24" Palmyra Push Broom Head	6	Corrugate Sleeve
1436P12	24" Palmyra push broom head, resin garage block	6	Corrugate Sleeve



PUSH BROOMS — THREADED WOOD BLOCK

HARPER'S® traditional hardwood block push brooms are an economical choice for your cleaning tool needs. The lacquered hardwood block broom heads feature a dual threaded handle hole that will accept any standard threaded handle, so finding the right replacement handle is never a problem. Available in a variety of bristle types for cleaning wet or dry material, these brooms can sweep any type of debris indoors or outdoors.

INDOOR • DRY DEBRIS



- Dual threaded handle hole hardwood block will accept any standard threaded handle
- All-natural, horsehair bristles
- Sweeps fine, dry dust and light debris such as paper shavings, pet hair, and small particles
- Use indoors on dry, smooth, and highly-polished surfaces
- Do not use on wet surfaces
- Ideal for schools, office buildings, hospitals, and commercial shops

Part No	Description	Qty/Master Carton	Package
347	18" Indoor all-natural horsehair push broom head	6	Corrugate Sleeve
348	24" Indoor all-natural horsehair push broom head	6	Corrugate Sleeve



- Dual threaded handle hole hardwood block will accept any standard threaded handle
- All-natural horsehair and synthetic blended bristles
- Sweeps fine, dry dust and debris such as sand, saw dust, and small particles
- Use indoors on dry, smooth surfaces
- Ideal for schools, office buildings, hospitals, and smooth concrete

Part No	Description	Qty/Master Carton	Package
581918-1	18" Indoor horsehair blend push broom head	4	Sleeve
581924-1	24" Indoor horsehair blend push broom head	4	Sleeve



PUSH BROOMS — THREADED WOOD BLOCK

INDOOR • DRY DEBRIS



- Dual threaded handle hole hardwood block will accept any standard threaded handle
- Fine, split-tip synthetic bristles
- Sweeps fine, dry dust and light debris such as sand, wood shavings, saw dust, and pet hair
- Use indoors on dry, smooth surfaces
- Ideal for warehouses, basements, sealed concrete, offices, and garages

Part No	Description	Qty/Master Carton	Package
582218	18" Indoor push broom head	4	Label
582218SC	18" Indoor push broom, side-clipped with 15/16" x 60" wood handle with threaded metal tip	4	Sleeve
582224	24" Indoor push broom head	4	Label
582224SC	24" Indoor push broom, side-clipped with 15/16" x 60" wood handle with threaded metal tip	4	Sleeve
582236	36" Indoor push broom head	3	Label

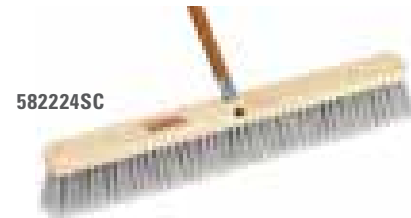

PUSH BROOMS — THREADED WOOD BLOCK

INDOOR/OUTDOOR • HIGH-TEMPERATURE DEBRIS



- Dual threaded handle hole hardwood block will accept any standard threaded handle
- Natural, heat-resistant Tampico bristles
- Sweeps metal shavings, filings and industrial chemicals
- Use indoors or outdoors on dry surfaces
- Ideal for welding shops, foundries and high-temperature surfaces or debris

Part No	Description	Qty/Master Carton	Package
583218	18" Tampico push broom head	4	Label
583224	24" Tampico push broom head	4	Label
583236	36" Tampico push broom head	3	Label



INDOOR/OUTDOOR • DRY DEBRIS



- Dual threaded handle hole hardwood block will accept any standard threaded handle
- Dual bristles for maximum cleaning power
- Stiff interior bristles dislodge stuck on dirt and debris
- Fine, split-tip outer bristles pick up small particles
- Sweeps everything from dust to mid-weight debris, dirt, leaves and gravel
- Use indoors or outdoors on dry surfaces
- Ideal for workshops, basements, garage floors, patios, sidewalks, and decks
- Assembled push broom comes with a 15/16" x 60" threaded metal handle and steel brace

Part No	Description	Qty/Master Carton	Package
583118	18" All-purpose dry debris push broom head	4	Label
583118SC	18" All-purpose dry debris push broom, side-clipped with 15/16" x 60" wood handle with threaded metal tip	4	Sleeve
583124	24" All-purpose dry debris push broom head	4	Label
583124SC	24" All-purpose dry debris push broom, side-clipped with 15/16" x 60" wood handle with threaded metal tip	4	Sleeve
583124A-1	24" Assembled all-purpose dry debris push broom with steel brace	4	Label



PUSH BROOMS — THREADED WOOD BLOCK

INDOOR/OUTDOOR • WET AND DRY DEBRIS



- Dual threaded handle hole hardwood block will accept any standard threaded handle
- Semi-stiff bristles for all surfaces
- Sweeps everything from mid-weight to heavy dirt, leaves, gravel and mulch
- Use indoors or outdoors on wet or dry surfaces
- Ideal for garage floors, patios, sidewalks, barns, and decks

Part No	Description	Qty/Master Carton	Package
213	18" Multi-use wet & dry clean-up push broom head	6	Corrugate Sleeve
200	18" Multi-use wet & dry clean-up push broom, side-clipped with 15/16" x 60" wood handle with threaded metal tip	4	Sleeve
214	24" Multi-use wet & dry clean-up push broom head	6	Corrugate Sleeve
201	24" Multi-use wet & dry clean-up push broom, side-clipped with 15/16" x 60" wood handle with threaded metal tip	4	Sleeve
203	36" Multi-use wet & dry clean-up push broom head	6	Corrugate Sleeve



OUTDOOR • WET AND DRY DEBRIS



- Dual threaded handle hole hardwood block will accept any standard threaded handle
- Stiff sweeping synthetic bristles
- Sweeps heavy mulch, gravel, dirt, soil and Oil Dri®
- Use outdoors on rough wet or dry surfaces
- Ideal for seasonal clean-up, landscaping, plants, barns, and parking lots

Part No	Description	Qty/Master Carton	Package
587918	18" Rough surface push broom head	4	Label
587918SC	18" Rough surface push broom, side-clipped with 15/16" x 60" wood handle with threaded metal tip	4	Sleeve
587924	24" Rough surface push broom head	4	Label
587924SC	24" Rough surface push broom, side-clipped with 15/16" x 60" wood handle with threaded metal tip	4	Sleeve
587936	36" Rough surface push broom head	6	Corrugate Sleeve



PUSH BROOMS — THREADED WOOD BLOCK

OUTDOOR • HEAVY WET AND DRY DEBRIS



- Dual threaded handle hole hardwood block will accept any standard threaded handle
- Natural, stiff Palmyra bristles for tough cleaning of heavy dirt and debris
- Long 4" trim length for sweeping power
- Sweeps heavy debris, gravel, wet grass, rocks, mulch and dirt
- Use outdoors on rough wet or dry surfaces
- Ideal for job sites, rough wooden floors, rough concrete, asphalt and parking lots
- Assembled push broom comes with a 15/16" x 60" threaded metal handle and steel brace

Part No	Description	Qty/Master Carton	Package
409	18" Palmyra push broom head	6	Corrugate Sleeve
408	18" Palmyra push broom, side-clipped with 15/16" x 60" wood handle with threaded metal tip	4	Sleeve
255	18" Palmyra push broom, side-clipped with 15/16" x 60" metal handle with threaded tip	4	Sleeve
405	24" Palmyra push broom head	6	Sleeve
410	24" Palmyra push broom head	6	Corrugate Sleeve
247	24" Palmyra push broom, side-clipped with 15/16" x 60" wood handle with threaded metal tip	4	Sleeve
256	24" Palmyra push broom, side-clipped with 15/16" x 60" metal handle with threaded tip	4	Sleeve
278A	24" Assembled Palmyra push broom with steel brace	4	Label



PUSH BROOMS — THREADED WOOD BLOCK

OUTDOOR • STREET AND BARN BROOMS



- Dual threaded handle hole hardwood block will accept any standard threaded handle
- Stiff sweeping synthetic bristles
- Sweeps heavy gravel, mulch and heavy dirt
- Use outdoors on rough wet or dry surfaces
- Ideal for street departments, landscaping, roofing job sites, roadwork, and barns
- Assembled push broom comes with a 15/16" x 60" threaded wood handle and steel brace

Part No	Description	Qty/Master Carton	Package
589624	24" Safety orange street debris push broom head	4	Label
589624A	24" Assembled safety orange street debris push broom with steel brace	4	Label

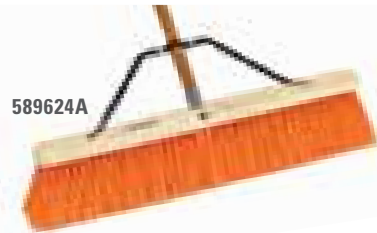

589624A



- Dual threaded and poke hole hardwood block will accept any standard threaded or tapered handle
- Extra long stiff sweeping synthetic bristles
- Sweeps heavy gravel, mulch and heavy dirt
- Use outdoors on rough wet or dry surfaces
- Ideal for street departments, landscaping, roofing job sites, roadwork, and barns
- Assembled push broom comes with a 15/16" x 60" tapered wood handle and steel brace

Part No	Description	Qty/Master Carton	Package
454	16" Street & barn push broom head, 5 1/8" synthetic bristles	6	Corrugate Sleeve
451	16" Street & barn push broom head, 6 1/4" Natural India bristles	6	Corrugate Sleeve
454A	16" Assembled street & barn push broom with steel brace, 5 1/8" synthetic bristles	4	Label
9816A	16" Assembled safety orange street debris push broom with steel brace, 6 1/4" synthetic bristles	4	Label



9816A



454A



454



PUSH BROOMS — STRUCTURAL RESIN BLOCK

HARPER'S® structural resin block push brooms are made with reinforced structural foam that resists chipping, cracking, warping or bending as well as mold and mildew buildup. Available in a bristle type to match any condition or surface, they're an economical choice for cleaning indoors or outdoors on wet or dry, rough or smooth surfaces. The threaded handle hole on the block accepts any standard threaded handle.

INDOOR • DRY DEBRIS



- Structural resin block will not crack, warp, or bend
- Dual threaded hole block will accept any standard threaded handle
- Soft, split-tip synthetic bristles
- Sweeps fine dust and light debris such as sand, paper shavings, and small particles
- Use indoors on dry, smooth surfaces
- Ideal for sealed concrete, wood floors, basements, and gymnasiums

Part No	Description	Qty/Master Carton	Package
259	18" Indoor push broom, side-clipped with 15/16" x 60" metal handle with threaded tip	4	Sleeve
258	24" Indoor push broom, side-clipped with 15/16" x 60" metal handle with threaded tip	4	Sleeve



258



PUSH BROOMS — STRUCTURAL RESIN BLOCK

INDOOR/OUTDOOR • DRY DEBRIS



- Structural resin block; will not crack, warp, or bend
- Dual threaded hole block will accept any standard threaded handle
- Dual bristles for maximum cleaning power
- Stiff interior bristles dislodge stuck on dirt and debris
- Fine, split-tip outer bristles pick up small particles
- Sweeps everything from dust to mid-weight debris, dirt, leaves and gravel
- Use indoors or outdoors on dry surfaces
- Ideal for workshops, basements, garage floors, patios, sidewalks and decks
- Assembled push broom comes with a 15/16" x 60" powder-coated metal handle and steel brace



Part No	Description	Qty/Master Carton	Package
257	18" All-purpose dry debris push broom, side-clipped with 15/16" x 60" metal handle with threaded tip	4	Sleeve
260	24" All-purpose dry debris push broom, side-clipped with 15/16" x 60" metal handle with threaded tip	4	Sleeve
260A	24" Assembled all-purpose dry debris push broom with steel brace	4	Label

INDOOR/OUTDOOR • WET AND DRY DEBRIS



- Structural resin block with built-in squeegee – patented design
- Threaded hole block will accept any standard threaded handle
- Dual bristles for maximum cleaning power
- Stiff interior bristles dislodge stuck on dirt and debris
- Fine outer bristles pick up small particles
- Sweeps dirt, soil, mulch, grass, gravel and Oil Dri®
- Use indoors or outdoors in wet or dry conditions
- Ideal for seasonal clean-up, plants, patios, garages, and sheds
- Squeegee for liquid, muck, sludge, and wet debris removal
- Assembled push broom comes with a 15/16" x 60" powder-coated metal handle and steel brace



Part No	Description	Qty/Master Carton	Package
1525SC	24" Multi-surface wet & dry clean up push broom with squeegee, side-clipped with 15/16" x 60" metal handle with threaded tip	4	Sleeve
1524A-1	24" Assembled multi-surface wet & dry clean up push broom with squeegee and steel brace	4	Label



PUSH BROOMS — STRUCTURAL RESIN BLOCK

OUTDOOR • WET AND DRY DEBRIS



- Structural resin block; will not crack, warp, or bend
- Dual threaded hole block will accept any standard threaded handle
- Dual bristles for maximum cleaning power
- Super stiff interior bristles dislodge stuck on dirt and debris
- Stiff, fine outer bristles pick up small particles
- Sweeps dirt, soil, mulch, wet grass, wood and Oil Dri®
- Use outdoors on wet or dry surfaces
- Ideal for garage floors, driveways, patios, sidewalks, asphalt, and barns



Part No	Description	Qty/Master Carton	Package
304	18" All-purpose wet & dry clean up push broom head	6	Sleeve
261	18" All-purpose wet & dry clean up push broom, side-clipped with 15/16" x 60" metal handle with threaded tip	4	Sleeve
305	24" All-purpose wet & dry clean up push broom head	6	Sleeve
264	24" All-purpose wet & dry clean up push broom, side-clipped with 15/16" x 60" metal handle with threaded tip	4	Sleeve



- Structural resin block; will not crack, warp, or bend
- Dual threaded hole block will accept any standard threaded handle
- 4" stiff sweeping synthetic bristles
- Sweeps heavy mulch, gravel, dirt, rocks and Oil Dri®
- Use outdoors on rough wet or dry surfaces
- Ideal for job sites, seasonal clean-up, landscaping, and barns



Part No	Description	Qty/Master Carton	Package
297	18" Heavy-duty rough surface push broom side-clipped with 15/16" x 60" metal handle with threaded tip	4	Sleeve
267	24" Heavy-duty rough surface push broom side-clipped with 15/16" x 60" metal handle with threaded tip	4	Sleeve





BROOMS

- Corn Brooms
- Angle Brooms
- Upright Brooms

HARPER has three families of quality brooms to choose from, each designed and engineered to get the job done right. Need to sweep up pet hair and crumbs in the kitchen? Doing spring clean-up in the garage or outside on the patio? Need to do some detailed cleanup on the job site? No matter what the location, the surface or type of debris, there's a HARPER broom designed to meet the challenge — at home, in the yard, or on the job site.

 **ENGINEERED FOR PROFESSIONAL DAILY USE**

CORN BROOMS

- High-quality, reinforced construction
- Head will not loosen or twist
- Use in wet or dry conditions
- Indoors and outdoors cleanup



Part No	Description	Qty/Pkg	Package
H100	Heavy-duty professional grade corn broom	4	Bag with label
7020	Janitor broom	6	Bag with label
469	Warehouse broom	6	Bag with label



- H100**
- Professional strength and sweeping power, 100% corn broom
 - Extra large 14" sweeping face
 - Reinforced, 4 sew-and-wire band construction
 - 40" hardwood handle
 - Ideal for use on job sites, landscaping, seasonal clean-up and barns

- 7020**
- Extreme sweeping power and mixed corn fiber
 - Extra reinforcement with 6-sew construction
 - 12" sweeping face
 - 39" heavy-duty wood handle
 - Ideal for sweeping on patios, job sites, offices, and garages

- 469**
- Heavy-duty warehouse broom, mixed corn fiber
 - Reinforced 4 sew-and-wire band construction
 - Over 10" sweeping face
 - 39" heavy-duty wood handle
 - Ideal for offices, warehouses, garage bays, and patios

CORN BROOMS

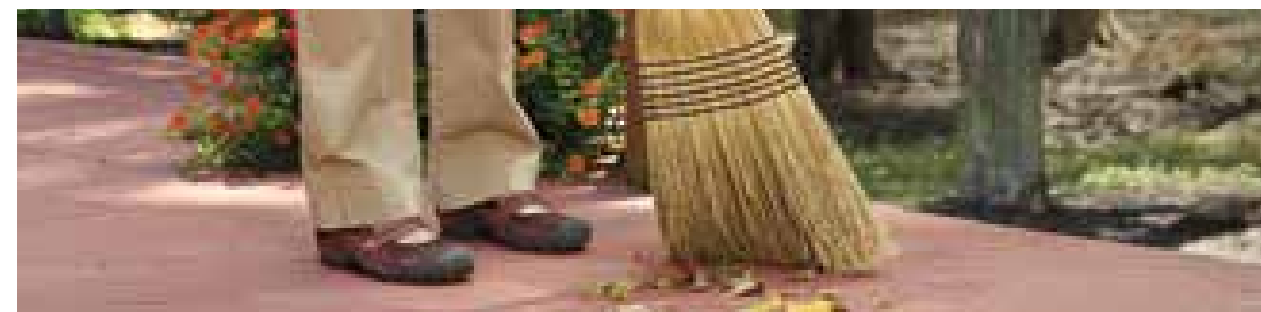

Part No	Description	Qty/Pkg	Package
466	Household corn broom	6	Bag with label
474	Lobby corn broom	12	Bag with label
530	Premium whisk broom	12	Hang tag
10779	Whisk broom	12	Hang tag



- 466**
- Indoor, light duty mixed corn fiber broom
 - Reinforced 4-sew construction
 - 11" sweeping face
 - 39" durable metal handle, with convenient hang-up hole
 - Ideal for utility rooms, basements, and garage floors

- 474**
- Compact, easy-to-sweep lobby broom
 - Reinforced 2-sew construction
 - Over 6" sweeping face
 - 28" lightweight painted wood handle
 - Ideal for reaching under and around furniture and small spaces



- 530**
- Handy, professional-grade 100% corn whisk broom
 - Reinforced 2-sew construction
 - 8" sweeping face
 - Indoor/outdoor use to sweep dirt and debris

- 10779**
- Mixed corn fiber whisk broom
 - Reinforced 2-sew construction
 - 8" sweeping face
 - Indoor/outdoor use to sweep dirt and debris



ANGLE BROOMS

- Soft, split-tip synthetic fibers control and trap debris
- Various sized sweeping faces for both large and compact areas
- Best for dry dust, dirt and pet hair
- Great to use around the home or in the garage, warehouse or shop

Part No	Description	Qty/Pkg	Package
4047	Giant angle broom	6	Bag with label
476	Large all-purpose angle broom	6	Bag with label
4048	Utility angle broom with dustpan	6	Bag with label



Comfort Grip

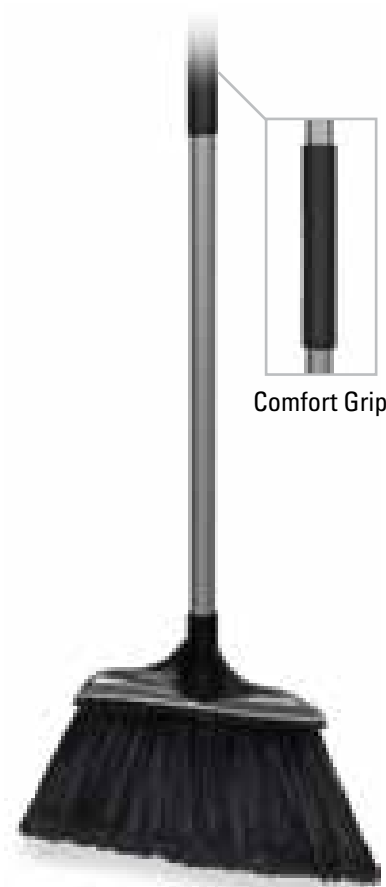

Comfort Grip

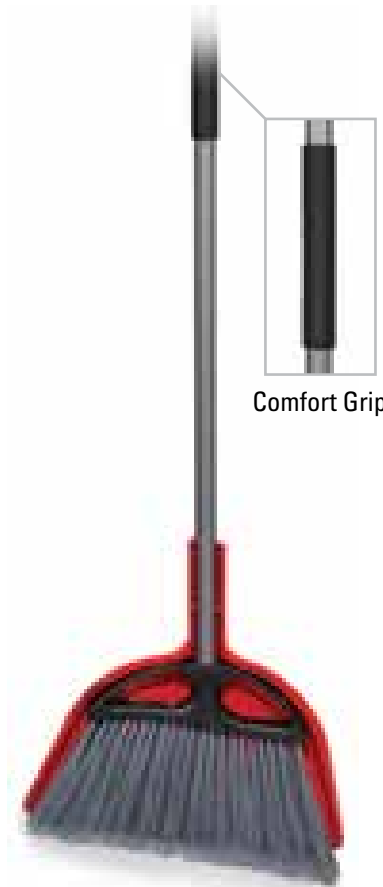

Comfort Grip



- 4047**
- Giant 16" sweeping area
 - Cleans large areas quickly, pushes heavier debris
 - 48" heavy-duty metal handle features comfort grip with hang-up storage hole
 - Ideal for garages, shops, basements, and utility rooms

- 476**
- Durable all-purpose broom for indoor/outdoor cleanup
 - Controls and traps dust, pushes heavier debris
 - 14.5" sweeping face
 - 48" heavy-duty metal handle features comfort grip with hang-up storage hole
 - Ideal for garages, basements, kitchens and shops

- 4048**
- Large all-purpose angle broom and snap-on dustpan
 - Controls and traps dust, pushes heavier debris
 - 13" sweeping face
 - 48" heavy-duty metal handle features comfort grip with hang-up storage hole
 - Sturdy dust pan with built-in teeth to clean the bristles
 - Ideal for kitchens, laundry rooms, wood floors and tile



ANGLE BROOMS



Part No	Description	Qty/Pkg	Package
4042	Long reach angle broom	6	Bag with label
477ND	2-in-1 angle broom	12	Bag with label
475	Compact household angle broom	6	Bag with label
4045L	Lobby angle broom	6	Bag with label



- 4042**
- Long-reach fibers for corners and baseboards
 - Easily reach hidden dirt
 - 12" sweeping face
 - 48" metal handle with hang-up storage hole
 - Ideal for kitchens, laundry rooms, wood floors and tile



- 477ND**
- Angle broom and whisk broom in one
 - Simply remove handle for close-up cleaning
 - 48" lightweight handle with hang-up hole
 - Ideal for laundry rooms, bathrooms, and apartments



- 475**
- Easy to maneuver and reach small spaces
 - Small size is easy to store
 - 48" lightweight handle with hang-up hole
 - Ideal for laundry rooms, bathrooms, and apartments

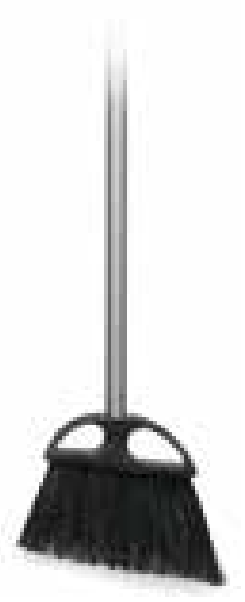

- 4045L**
- Compact, easy-to-sweep lobby broom
 - Use with HARPER debris pans
 - 36" lightweight handle with hang-up hole
 - Ideal for reaching under and around furniture and small spaces



★ UPRIGHT BROOMS

Manufactured with the same care and attention to detail as the Red End Push Brooms, HARPER® Upright Brooms make a quick “sweep” of wet and dry debris whether it’s indoors or outdoors.

- Smaller broom for detailing and final touches
- Allows the fiber to do all of the work and leave less behind



- Quality hardwood block with protective bumper
- Fine, split-tip Polystyrene fibers designed for dry debris, dust and hair
- 90-degree threaded handle hole
- Best for indoor smooth surfaces such as tile, wood floors, sealed concrete

Part No	Description	Qty/Pkg	Package
105-1	9" Smooth sweep indoor upright broom head	6	Label
10516A-1	9" Smooth sweep indoor upright broom with 48" metal handle	6	Label
108-1	12" Smooth sweep indoor upright broom head	4	Label
10804A	12" Smooth sweep indoor upright broom with 48" metal handle	4	Label



105-1

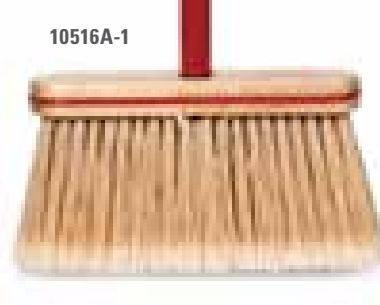

10516A-1



- Quality hardwood block with protective bumper
- Fine, split-tip Polystyrene fibers designed for dry debris, dust and hair
- Angled bristles reach under furniture and clean base boards
- 90-degree threaded handle hole
- Best for indoor smooth surfaces like tile, wood floors and sealed concrete

Part No	Description	Qty/Pkg	Package
115-4	9" Angled smooth sweep indoor upright broom head	6	Label
115-4A	9" Angled smooth sweep indoor upright broom with 48" metal handle	6	Label
118-4	12" Angled smooth sweep indoor upright broom head	4	Label



118-4

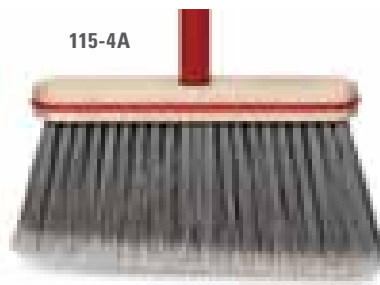

115-4A



★ UPRIGHT BROOMS



- Quality hardwood block with protective bumper
- Stiff sweeping durable synthetic fibers
- Designed for wet or dry clean-up
- 90-degree threaded handle hole
- Use on outdoors or rough surfaces like patios, driveways, job sites, mills and

Part No	Description	Qty/Pkg	Package
109	9" Stiff sweep upright broom head	6	Label
109A	9" Stiff sweep upright broom with 48" metal handle	6	Label
112	12" Stiff sweep upright broom head	4	Label
11202A	12" Stiff sweep upright broom with 48" metal handle	4	Label
471012	12" Stiff sweep upright broom head, plastic block with bumper	4	Label



112



109A



- Quality hardwood block
- 60-degree threaded handle hole for pushing or pulling debris
- Ideal to reach under furniture or bus, restaurant, and theater seats
- Fine, split-tip Polystyrene fibers best for dry debris, dust and hair (Part No. 111, Part No. 117)
- Blended synthetic fibers clean wet or dry light debris (Part No. 110)

Part No	Description	Qty/Pkg	Package
110	9" Blended bristle wood broom head	6	Label
111	9" Fine sweep wood broom head, 4" trim	6	Label
117	9" Fine sweep wood broom head, 3" trim	6	Label



110



117





WASH BRUSHES

Built to remove the toughest grime, but soft enough to use on the finest finishes, HARPER® wash brushes are made to retain water and perform well when immersed for long durations even when used with the harshest cleaning solutions. Available with a variety of fiber bristle types for multiple uses — best-in-class nylon, premium polyester, or gentle polystyrene. Designed for commercial uses or when cleaning RVs, trucks, motor homes, windows, siding and more. So, whether it's a large area or a hard-to-clean space, HARPER has a wash brush to fit any cleaning need to get the job done right.

 **ENGINEERED FOR PROFESSIONAL DAILY USE**

BEST-IN-CLASS NYLON WASH BRUSHES



- Ultra soft, split-tip Nylon fiber safe on all surfaces, including clear coat
- Bristles resist most acids and alkalis and can be used in high-temperature environments
- Heavy-duty structural foam resin block
- Nylon bristles allow for maximum liquid retention
- Flow-through handle hole, use with any standard threaded handle
- Ideal for commercial uses including fleets, tractor trailers, vehicles, RVs, car detailing

Part No	Description	Qty/Pkg	Package
685508	8" Nylon bumpered wash brush head	12	Label
685510	10" Nylon bumpered wash brush head	12	Label
686614	14" Nylon wash brush head	6	Label
885510	10" Nylon tri-level wash brush head	6	Label



PREMIUM POLYESTER WASH BRUSHES



- Premium split-tip Polyester fiber safe on all surfaces
- Durable bristles for use with a wide range of cleaning chemicals
- Heavy-duty structural foam resin block
- Flow-through handle hole, use with any standard threaded handle
- Good for RVs, trucks, motor homes, windows, siding and more

Part No	Description	Qty/Pkg	Package
1200	8" Polyester bumpered wash brush head	12	Label
1201	8" Polyester bumpered wash brush head	12	Sleeve
1100	10" Polyester bumpered wash brush head	12	Label
1101	10" Polyester bumpered wash brush head	12	Sleeve
1508	10" Polyester bi-level wash brush head	8	Label
8150	14" Polyester wash brush head	6	Label



800.393.1846 | WWW.HARPERBRUSH.COM

DURABILITY PROS RELY ON

GENTLE POLYSTYRENE WASH BRUSHES

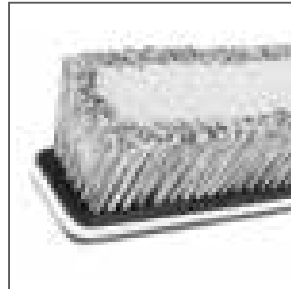

- Gentle split-tip Polystyrene fiber safe on all surfaces
- Durable bristles for use with a wide range of soaps
- Border bristles move dirt, interior bristles hold soap and water
- Heavy-duty structural foam resin block
- Flow-through handle hole, use with any standard threaded handle
- Ideal for RVs, trucks, motor homes, personal watercraft, windows, siding and more

Part No	Description	Qty/Pkg	Package
1299	8" Polystyrene bumpered wash brush head	12	Sleeve
1102	10" Polystyrene bumpered wash brush head	12	Label
1103	10" Polystyrene bumpered wash brush head	12	Sleeve
1512	8" Polystyrene bumpered wash brush head, wood block	6	Label
1510	10" Polystyrene bi-level wash brush head	8	Sleeve
887310	10" Polystyrene tri-level wash brush head	6	Label
8151	14" Polystyrene wash brush head	6	Label
2718	18" Polystyrene wash brush head	12	Label
2724	24" Polystyrene wash brush head	12	Label

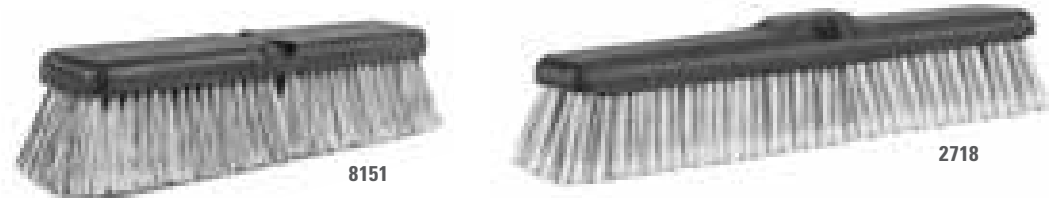

800.393.1846 | WWW.HARPERBRUSH.COM

GENTLE POLYSTYRENE WASH BRUSHES WITH HANDLES

METAL HANDLES

- Quality metal powder coated handles
- Reinforced threaded tip
- Convenient handle hang-up hole

Part No	Description	Qty/Pkg	Package
12973	8" Polystyrene bumpered wash brush w/48" handle	6	Sleeve
11021L	10" Polystyrene bumpered wash brush w/54" handle	4	Sleeve
1451	8" Polystyrene bi-level wash brush w/48" handle	6	Sleeve
887310A	10" All-purpose polystyrene tri-level wash brush w/54" handle	4	Sleeve



TELESCOPIC ALUMINUM HANDLES

- Durable aluminum telescopic design
- Lightweight
- Easy to extend for use and compact for storage

Part No	Description	Qty/Pkg	Package
12712	8" Polystyrene bumpered wash brush w/27" to 48" telescoping handle	6	Sleeve
14081	8" Polystyrene bi-level wash brush w/27" to 48" telescoping handle	6	Sleeve



TELESCOPIC FLOW-THROUGH HANDLES

- Durable aluminum telescopic handles with water control valve
- Lightweight
- Comfort grip
- Extends to reach top of large vehicles, windows, RVs and trucks

Part No	Description	Qty/Pkg	Package
12717	8" Polystyrene bumpered wash brush w/37" to 64" telescoping flow-through handle	6	Sleeve
11715	10" Polystyrene bumpered wash brush w/37" to 64" telescoping flow-through handle	6	Sleeve
14083	8" Polystyrene bi-level wash brush w/37" to 64" telescoping flow-through handle	6	Sleeve
15168	10" Polystyrene bi-level wash brush w/39" to 66" flow through telescoping handle	6	Sleeve



800.393.1846 | WWW.HARPERBRUSH.COM

DURABILITY PROS RELY ON

STIFF SCRUBBING WASH BRUSHES



- Stiff scrubbing synthetic fibers
- Durable bristles for use with a wide range of cleaning chemicals
- Durable bristles maintain shape
- Heavy-duty structural foam resin block
- Flow-through handle hole, use with any standard threaded handle
- Ideal for commercial use including cement trucks, construction equipment, semi trailers and farm implements



Part No	Description	Qty/Pkg	Package
686508X	8" All-purpose Tampyl wash brush head	12	Label
686510X	10" All-purpose Tampyl wash brush head	12	Label
886510	10" All-purpose Tampyl tri-level wash brush head	6	Label
1125	10" Stiff synthetic wash brush head	8	Label
1524	10" Bi-level scrub brush head	8	Label
897510	10" Synthetic tri-level deck/wall wash brush head	12	Label



★ SPECIALTY WASH BRUSHES



- All-natural Horsehair fiber
- Safe on all surfaces
- Compact size cleans small spaces
- Heavy-duty structural foam resin block
- Ideal for creating finishes with plaster and paint

Part No	Description	Qty/Pkg	Package
1055	4-1/2" Horsehair round finishing brush head	6	Label



- Gentle split-tip Polystyrene fiber
- Durable bristles for use with a wide range of soaps
- Heavy-duty structural foam resin block
- Ideal for cleaning vehicle wheels and rims

Part No	Description	Qty/Pkg	Package
H356	4-1/2" Polystyrene round wash brush head	6	Label



FLOOR SQUEEGEES

Whether you're cleaning a pool deck or patio, garage or warehouse bay, HARPER has a squeegee to move water, liquid debris, snow and slush. There's a tool designed for any task, from light duty for the home to heavy duty for professional daily use. Multiple materials and designs are available, making every job an easy one.

Unique to the HARPER line of squeegees is the PowrWave® with its patented Fluid Control System. Liquids are moved forward in a powerful wave-like action, making cleanup a breeze.

★ ENGINEERED FOR PROFESSIONAL DAILY USE



FLOOR SQUEEGEES



Fluid Control System
Pushes liquid forward better than conventional designs

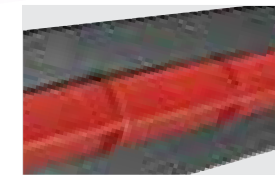

Squeegee View

- PowrWave® patented design
- Dual sided, extra-durable rubber blades
- Gated squeegee creates a Fluid Directional Control
- 40% more effective than traditional squeegees at moving liquid forward
- Extra-strong plastic frame
- Best for semi-smooth to smooth surfaces indoors or out

Part No	Description	Qty/Pkg	Package
5324224A	24" Assembled PowrWave squeegee with 1-1/8" x 60" wood handle	4	Label
1524224A	24" Assembled PowrWave squeegee with 1-1/8" x 60" wood handle	4	Label/Flag
5324224PI	24" PowrWave squeegee — easy to ship, ready to assemble with brace and handle — internet solution	1	Box
24224	24" PowrWave squeegee head	8	Label



- Twin foam curved blades
- Durable steel construction
- 1-1/8" x 54" hardwood handle with comfort end grip
- Unbreakable Connector flexes and bends
- Best for semi-smooth to smooth surfaces indoors or out

Part No	Description	Qty/Pkg	Package
574552A	24" Assembled curved foam squeegee with 1-1/8" x 54" unbreakable wood handle with Unbreakable Connector	3	Label



- Twin moss foam rubber blades
- Quality steel plated body and handle socket
- 15/16" x 54" hardwood handle
- Clears light and mid-weight liquid debris
- Best for semi-smooth to smooth surfaces indoors or out

Part No	Description	Qty/Pkg	Package
25322A	22" Assembled moss foam squeegee with 15/16" x 54" wood handle	8	Label



800.393.1846 WWW.HARPERBRUSH.COM

DURABILITY PROS RELY ON

FLOOR SQUEEGEES



569

- Durable black rubber blade
- Plated, corrosion resistant steel construction
- Steel handle socket for tapered handles
- Attachment hardware included
- Best for semi-smooth to smooth floor surfaces indoors or out
- Assembled squeegees come with a 1-1/8" x 54" tapered wood handle with steel brace

Part No	Description	Qty/Pkg	Package
569	24" Curved rubber squeegee head	6	Label
571	36" Curved rubber squeegee head	6	Label
567	24" Straight rubber squeegee head	6	Label
567552	24" Straight rubber squeegee, side-clipped with 54" tapered wood handle	4	Label
567552A	24" Assembled straight rubber squeegee with steel brace	4	Label
570	36" Straight rubber squeegee head	6	Label



571



567



570



25018

- Twin moss foam quick-drying rubber blades
- Quality steel-plated body and handle socket
- Efficiently clears light- and mid-weight liquid debris
- Best for semi-smooth to smooth floor surfaces indoors or out

Part No	Description	Qty/Pkg	Package
25018	18" Moss foam squeegee head	10	Label
25322	22" Moss foam squeegee head	10	Label
25330	30" Moss foam squeegee head	10	Label

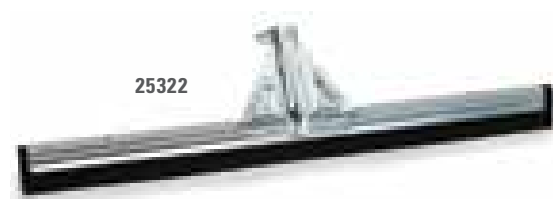

25322



25330

★ FLOOR SQUEEGEES - PROFESSIONAL GRADE, HEAVY DUTY



- Rubber blade, 1/4" thick x 3-1/2" wide
- Effectively cleans heavy debris on all types of surfaces
- Curved ends enhance debris containment

Part No	Description	Qty/Pkg	Package
24724	24" Curved double-edge rubber squeegee	6	Label
24824R	Replacement, refill blades for 24724	24	Label
24730	30" Curved double-edge rubber squeegee	3	Label
24830R	Replacement, refill blades for 24730	12	Label
H24736	36" Curved double-edge rubber squeegee	3	Label
24836R	Replacement, refill blades for H24736	12	Label



- Rubber blade, 1/4" thick x 3-1/2" wide
- Effectively cleans heavy debris on all types of surfaces
- Reversible blades extend squeegee life

Part No	Description	Qty/Pkg	Package
H24824	24" Double-edge rubber squeegee	10	Label
24824R	Replacement, refill blades for H24824	24	Label
H24830	30" Double-edge rubber squeegee	4	Label
24830R	Replacement, refill blades for H24830	12	Label
H24836	36" Double-edge rubber squeegee	4	Label
24836R	Replacement, refill blades for H24836	12	Label



- Dual moss foam blade, 3/8" thick x 3-1/2" wide
- Effectively cleans light and medium debris on smooth and rough surfaces
- Two reversible blades extend squeegee life and provide quick-drying action

Part No	Description	Qty/Pkg	Package
25524	24" Double-edge moss foam squeegee	6	Label
25524R	Replacement, refill blades for 25524	12	Label
25530	30" Double-edge moss foam squeegee	3	Label
25530R	Replacement, refill blades for 25530	12	Label
25536	36" Double-edge moss foam squeegee	3	Label
25536R	Replacement, refill blades for 25536	12	Label
25636	36" Curved double-edge moss foam squeegee	2	Label



- Hardwood handle for heavy duty moss foam floor squeegee heads
- Laquered wood

Part No	Description	Qty/Pkg	Package
248243H	1-1/8" x 60" squeegee handle	6	Label



100% NATURAL COTTON WET MOPS



- Super absorbent 4-ply 100% natural cotton
- Ideal for cleaning spills and general cleaning
- Use indoors on hardwood, linoleum, and tile floors
- 1-1/4" band secures easily to mop handle
- Use HARPER mop handles #495 and #6717 with mop heads

Part No	Description	Qty/Master Carton	Package
482	No. 12 cut end cotton wet mop head	12	Bag/Label
483	No. 16 cut end cotton wet mop head	12	Bag/Label
484	No. 20 cut end cotton wet mop head	12	Bag/Label
485	No. 24 cut end cotton wet mop head	12	Bag/Label
485A	No. 24 assembled cut cotton wet mop head, 60" wood handle	6	Bag/Label
490	No. 32 cut end cotton wet mop head	12	Bag/Label



BLENDED COTTON WET MOPS



- Super absorbent cotton blend
- Ideal for cleaning spills and general cleaning
- Use indoors on hardwood, linoleum, and tile floors
- Mop head band secures easily to handle
- Use HARPER mop handles #495 and #6717 with mop heads

Part No	Description	Qty/Master Carton	Package
489	No. 24 striped cut end cotton blend wet mop head	12	Bag/Label



BLENDED COTTON WET MOPS



- Super absorbent looped end cotton blend
- Tangle-free looped ends are durable, machine washable and easy to replace and clean
- Use indoors on hardwood, linoleum, and tile floors
- Mop head band secures easily to handle
- Use HARPER mop handles #495 and #6717 with mop heads

Part No	Description	Qty/Master Carton	Package
160201-2	No. 20 blue looped end cotton blend wet mop head	6	Bag/Label
487	No. 24 blue looped end cotton blend wet mop head	12	Bag/Label

RAYON BLEND WET MOPS



- Heavy-duty synthetic rayon blend
- Ideal for applying wax, finishes, and chemical solutions
- Use indoors on hardwood, linoleum, and tile floors
- Mop head band secures easily to handle
- Use Harper mop handles #495 and #6717 with mop heads

Part No	Description	Qty/Master Carton	Package
488	No. 24 cut end rayon blend wet mop head	12	Bag/Label

DECK MOPS



- 100% natural cotton compact deck mops
- 48" handle with hang up storage hole
- Ideal for small spills and general cleaning
- Use indoors on hardwood, linoleum and tile floors

Part No	Description	Qty/Master Carton	Package
486	No. 12 assembled cut end cotton deck mop	6	Label
479	No. 16 assembled cut end cotton deck mop	12	Label
480	No. 20 assembled cut end cotton deck mop	6	Label



MOP BUCKETS



7030

- Side-press wringer for liquid removal
- Holds up to 8 gallons of water
- Easy-carry handle
- Wheels for smooth movement and stability
- Ideal for schools, hospitals, gymnasiums, stores and shops

Part No	Description	Qty/Master Carton	Package
7030	Large wet mop bucket and wringer combo, 26 qt.	1	Box/Label



7031

- Divided buckets for dual use, cleaning solutions and water
- Holds up to 5 gallons of water
- Easy-carry handle with comfort grip
- Use indoors or outdoors
- Ideal for schools, homes, car washing and everyday use

Part No	Description	Qty/Master Carton	Package
7031	Red dual bucket, 19 qt.	6	Label



H268

- Large enough to fit most mops and sponges
- Holds up to 4 gallons of water
- Easy-carry handle with comfort grip
- Use indoors or outdoors
- Ideal for schools, homes, car washing and everyday use

Part No	Description	Qty/Master Carton	Package
H268	Red bucket, 17 qt.	6	Label



WINDOW SQUEEGEES

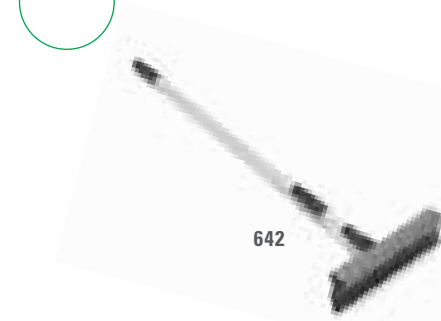

642



- 10" Dual sided plastic head with foam for scrubbing and heavy-duty blade for liquid removal
- Pivoting, lockable head for tricky, hard-to-clean angles
- 31" to 55" telescoping handle, extends for hard-to-reach areas and retracts for tight space cleaning, hang-up storage cap
- Ideal for car, trailer, and motorcycle windshields as well as household cleaning

Part No	Description	Qty/Master Carton	Package
642	10" window squeegee with telescoping handle	6	Label



648

- Dual sided head with foam for scrubbing and blade for liquid removal
- Ideal for car, trailer, and motorcycle windshield and window cleaning

Part No	Description	Qty/Master Carton	Package
648	8" Plastic window squeegee, side-clipped with 20" plastic handle	12	Sleeve
650	8" Metal window squeegee, side-clipped with 20" wood handle, red finish	12	Label
20508	8" Metal window squeegee head	12	Label
20710	10" Metal window squeegee head	12	Label

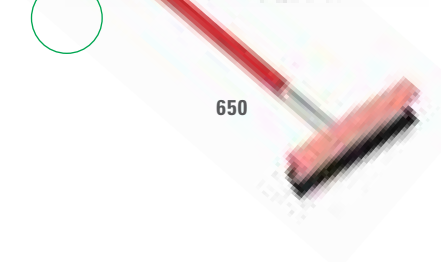

650



SPONGE MOPS



- 10" durable cellulose sponge
- Bonus scrub brush for removing stubborn dirt and grime
- Uses #308R replacement mop head
- Easy-to-rinse handle grip on 48" metal handle
- Convenient storage hang-up hole

Part No	Description	Qty/Pkg	Package
308	Household roller mop	4	Sleeve
308R	Household roller mop replacement head	6	Label

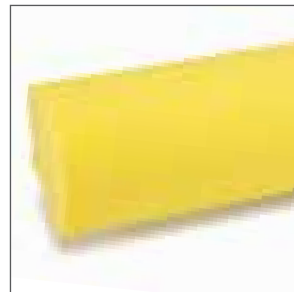

- 12" extra-large cellulose sponge
- Durable plastic construction with built-in scraper
- Uses #303R replacement mop head
- Easy-to-rinse handle grip on 48" metal handle
- Convenient storage hang-up hole

Part No	Description	Qty/Pkg	Package
H303	Butterfly mop	4	Sleeve
303R	Butterfly mop replacement head	6	Label

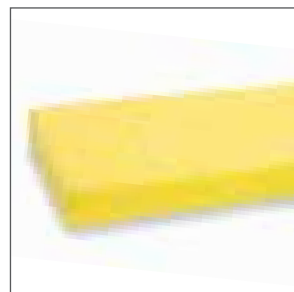

DUST MOPS



40624

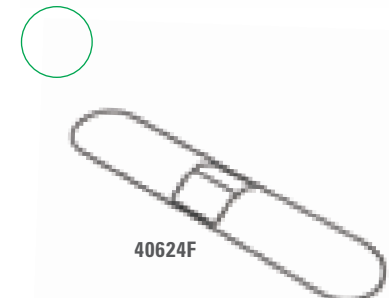

40624F

- 100% premium cotton, looped-ends for maximum dust retention and cleaning power
- Fabric back with snap closures
- Fits 5" metal frames
- Durable mop head is machine washable, easy to remove and clean

Part No	Description	Qty/Master Carton	Package
40624	24" Heavy-Duty Cotton Dust Mop Head	12	Bag/Label
40636	36" Heavy-Duty Cotton Dust Mop Head	12	Bag/Label

- Heavy-duty metal frame
- Reinforces mop head for 100% contact with sweeping surface
- 5" wide
- Use with quick-release handle part #40660H

Part No	Description	Qty/Master Carton	Package
40624F	24" Metal Dust Mop Frame	12	Label
40636F	36" Metal Dust Mop Frame	12	Label



40601A

- 24" x 5" dust mop head and metal frame, easy to maneuver
- 100% premium cotton, looped-ends for maximum dust retention and cleaning power
- Durable mop head is machine washable, easy to remove and clean
- Quick release swivel connector is ideal for smooth turning, tight angles, and fast removal of mop heads
- 1-1/8" x 60" lacquered wood handle
- Use on smooth, indoor surfaces to pick up dust and dirt
- Ideal for gymnasiums, hallways, schools, hospitals, cafeterias, and other large commercial areas

Part No	Description	Qty/Master Carton	Package
40601A	24" Assembled Heavy-Duty Cotton Dust Mop with Handle Release Swivel Connector	4	Label



DECK, SCRUB AND MASONRY BRUSHES

HARPER® offers an extensive line of deck, scrub and masonry brushes for wet or dry use on all outdoor surfaces. Whether it's for general cleaning to remove dirt, mud, sludge and grease or applying solvents and coatings, there is a wide selection of bristle types including stiff scrubbing synthetic, heat-resistant Tampico, all-natural Palmyra and heavy-duty wire.

 **ENGINEERED FOR PROFESSIONAL DAILY USE**



ASSEMBLED DECK BRUSHES



- Hardwood maple block
- Stiff scrubbing 2" synthetic bristles for deep cleaning of dirt, mud, sludge, and grease
- Use outdoors on all surfaces in wet or dry conditions
- Ideal for decks, concrete, patios, driveways, and barn floors
- 1-1/8" x 60" wood handle with bolt-on connector

Part No	Description	Qty/Master Carton	Package
53561912A	12" Assembled all-purpose deck brush	4	Label



- Hardwood block
- Unbreakable Connector absorbs shock and reduces impact
- Stiff scrubbing 2" synthetic bristles for dirt, mud, sludge, and grease
- Use outdoors on all surfaces in wet or dry conditions
- Ideal for decks, concrete, patios, driveways, and barn floors
- 1-1/8" x 54" wood handle with comfort grip

Part No	Description	Qty/Master Carton	Package
918AF	10" Assembled deck brush with Unbreakable Connector	6	Label
918AFS	10" Assembled deck brush with Unbreakable Connector and heavy-duty scraper	6	Label



- Reinforced plastic block
- Stiff scrubbing 2" synthetic bristles for dirt, mud, sludge, and grease
- Use outdoors on all surfaces in wet or dry conditions
- Ideal for decks, concrete and patios
- 7/8" x 48" powder-coated metal handle with easy storage hang-up hole

Part No	Description	Qty/Master Carton	Package
918	10" Assembled deck brush	6	Label

DECK BRUSH HEADS



- Dual threaded and poke hole hardwood block
- Use as a handheld scrub brush or with a standard threaded or tapered handle
- Cleans away dirt, mud, sludge, and grease
- Use outdoors on all surfaces in wet or dry conditions
- Ideal for decks, concrete, patios, and driveways



Part No	Description	Qty/Master Carton	Package
887	10" Synthetic deck brush head	24	Label
NBID-0006	10" Crimped synthetic deck brush head	12	Label
886	10" All-natural Palmyra deck brush head	24	Label



MASONRY ROOFING BRUSHES



- Dual threaded and poke hole hardwood block
- Use as a handheld brush or with a standard threaded or tapered handle
- Natural, heat-resistant Tampico bristles
- Tampico bristles are resistant to most solvents and coatings
- Use outdoors on all surfaces in wet or dry conditions
- Ideal for applying solvents, coatings, and for general cleaning
- Assembled brush comes with 7/8" x 48" powder-coated metal handle with easy storage hang-up hole

Part No	Description	Qty/Master Carton	Package
907	7" Tampico masonry brush head, 2" bristles	24	Label
157-14	7" Tampico masonry brush head, 2" bristles	14	Color PDQ Box
906A	7" Assembled Tampico masonry brush, 2" bristles	6	Label
908	7" Assembled Tampico masonry brush head, rubberwood block, 2" bristles	12	Label
914	8" Tampico masonry brush head, 1-1/8" bristles	12	Label
915	9-1/2" Tampico masonry brush head, 2" bristles	24	Label



- Threaded hardwood block
- Use as a handheld brush or with a standard threaded or tapered handle
- Natural, heat-resistant Tampico bristles
- Tampico bristles are resistant to most solvents and coatings
- Use outdoors on rough surfaces in wet or dry conditions
- Ideal for applying solvents, coatings, and general cleaning

Part No	Description	Qty/Master Carton	Package
909	6" 3-Knot Tampico masonry brush head	12	Label



- Threaded hardwood block with rubber squeegee
- All-natural Palmyra bristles
- Use outdoors on rough surfaces in wet or dry conditions
- Ideal for applying solvents, sealants, and cleaning solutions on driveways, concrete, and masonry surfaces

Part No	Description	Qty/Master Carton	Package
426-18	18" Palmyra brush head with rubber squeegee	18	Color PDQ Box
1038	18" Palmyra brush with rubber squeegee, side-clipped with 54" wood handle	12	Label

MASONRY ROOFING HANDHELD BRUSHES



- 6-1/2" handle, easy to hang and store
- Natural, heat-resistant Tampico bristles
- Tampico bristles are resistant to most solvents and coatings
- Use outdoors on wet or dry surfaces
- Ideal for applying solvents and coatings

Part No	Description	Qty/Master Carton	Package
902	6-1/2" Wood masonry brush with 2-row, 3" bristles	12	Label
901	6-1/2" Wood masonry brush with 4-row, 3" bristles	12	Label
900	6-1/2" Wood masonry brush with 5-row, 4" bristles	12	Label
549CC	6-1/2" Plastic masonry brush with 4" synthetic bristles	12	Label

SCRUB BRUSHES

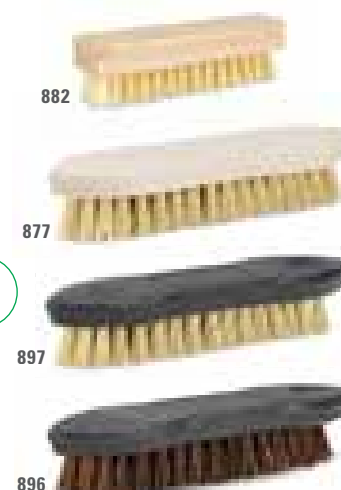

- Stiff scrubbing bristles remove dirt, mud, rust and grease
- Small profile for tight-space cleaning
- Use indoors or outdoors on rough surfaces in wet or dry conditions
- Ideal for sheds, outdoor furniture, water troughs, and machinery

Part No	Description	Qty/Master Carton	Package
882	4-3/4" Synthetic hand and nail brush, wood block	36	Label
877	9" Synthetic scrub brush, pointed wood block	24	Label
897	9" Synthetic scrub brush, pointed plastic block	12	Label
875	9" Tampico scrub brush, pointed wood block	12	Label
876	9" All-natural Palmyra scrub brush, pointed wood block	12	Label
896	9" All-natural Palmyra scrub brush, pointed plastic block	12	Label

WIRE BRUSHES



- Stiff scratching synthetic wire for heavy dirt, mud, rust, and grease removal
- Slim profile for tight-space cleaning
- Ergonomic curved handle for extra leverage, easy to hang and store
- Use indoors or outdoors on rough surfaces in wet or dry conditions
- Ideal for grills, water troughs, machinery, and rough metal surfaces

Part No	Description	Qty/Master Carton	Package
945	10" Heavy-duty wire scratch brush	12	Label
946	10" Heavy-duty wire scratch brush with metal scraper	12	Label
941	14" Heavy-duty wire scratch brush	12	Label
942	14" Heavy-duty wire scratch brush with metal scraper	12	Label



UTILITY BRUSHES

Whether it's a large, small or difficult-to-reach area, HARPER® Utility Brushes feature a variety of quality synthetic and natural fibers for every cleaning need. Our extensive assortment includes everything from handheld scrub brushes and outdoor deck brushes to indoor counter brushes. From gentle light-duty washing to detailed cleaning and acid-resistant brushes for heavy duty scrubbing, HARPER has a Utility Brush for every cleaning need at home or in an industrial workplace. Each is constructed with quality materials tested and engineered to meet the demands of a professional, and feature an ergonomic, easy grip block or our patented finger-groove handle for quick, efficient and comfortable cleaning.

★ ENGINEERED FOR PROFESSIONAL DAILY USE



★ PREMIUM SOFT SYNTHETIC BRUSH



- Polystyrene fiber is safe for all surfaces including clear coat
- Bristles resist solvents and most harsh chemicals along with high heat
- Durable resilient bristles maintain shape
- Good for agricultural, shop and automotive use

Part No	Description	Qty/Pkg	Package
221	8" Premium soft synthetic utility brush	12	Label
231	20" Premium soft synthetic utility brush	12	Label



SOFT SYNTHETIC BRUSH



- Split-tip fiber is safe for all surfaces including clear coat
- Bristles retain and absorb soap and water for efficient washing
- Works well with any household soaps and auto cleaners
- Good for automotive, marine and household washing

Part No	Description	Qty/Pkg	Package
8472	8" Soft synthetic utility brush	12	Label
8572	20" Soft synthetic utility brush	12	Label



★ NYLON BRUSH



- Ultra durable fiber
- Bristles resist mold, mildew, solvents, harsh chemicals and high heat
- Durable stiff bristles maintain shape
- Good for janitorial and commercial applications

Part No	Description	Qty/Pkg	Package
224	8" Nylon utility brush	12	Label
234	20" Nylon utility brush	12	Label



ALL PURPOSE SYNTHETIC BRUSH



- Long-lasting synthetic fiber
- Bristles resist solvents, harsh chemicals and high heat
- Stiff bristles scrub and wash everyday dirt buildup
- Good for fleets, heavy-duty trucks, RV and light industrial use

Part No	Description	Qty/Pkg	Package
H281	8" All purpose synthetic utility brush	12	Label
291	20" All purpose synthetic utility brush	12	Label



STIFF SYNTHETIC BRUSH



- Durable bristles for everyday scrubbing
- Super stiff bristles dislodge dirt, debris, grease and grime on uneven surfaces
- Good for scrubbing canvas, tires, and spring and fall outdoors cleanup

Part No	Description	Qty/Pkg	Package
8482	8" Stiff synthetic utility brush	12	Label
854	20" Stiff synthetic utility brush	12	Label

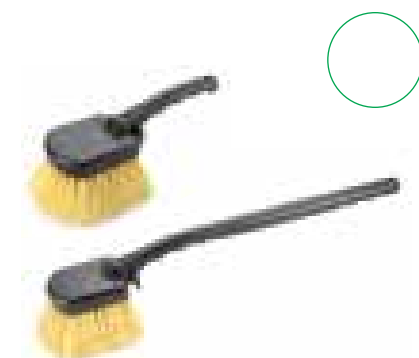

TAMPICO BRUSH



- All-natural acid-resistant fiber
- Bristles resist acids, high heat and harsh chemicals
- Can be used for wet or dry applications
- Good for general cleaning or applying sealants on any masonry surface

Part No	Description	Qty/Pkg	Package
8382	8" Tampico utility brush	12	Label
852	20" Tampico utility brush	12	Label

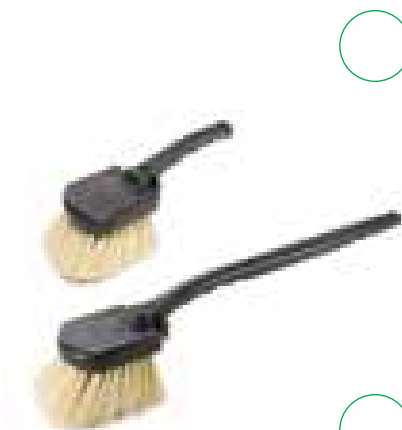

PALMYRA BRUSH



- All-natural stiff scrubbing fiber
- Bristles dislodge dirt, debris, grease and grime on rough uneven surfaces
- Tough scrubbing brush for value-conscious consumers
- Good for dislodging stubborn dirt

Part No	Description	Qty/Pkg	Package
849	8" Palmyra utility brush	12	Label
851	20" Palmyra utility brush	12	Label



COUNTER BRUSHES | UTILITY BRUSHES

Whether it's sweeping fine particles or heavy debris, there's a HARPER® Counter Brush for quick cleanup for any application or any surface — professional or around the house or garage. This complete line of brushes offers two block and handle material options; natural hardwood maple or heavy-duty molded structural foam resin.

★ PREMIUM HORSEHAIR BRUSH



- All-natural super soft fiber
- Bristles are scratch-free for smooth, highly polished surfaces
- Use on dry surfaces and debris only
- Good for commercial shops, wood shops, and professional use

Part No	Description	Qty/Pkg	Package
453	14" Horsehair wood block counter brush	12	Label



HORSEHAIR BLEND BRUSH



- Natural horsehair and soft synthetic blended fiber
- Bristles pick up and sweep fine dust and debris on smooth surfaces
- Use on dry surfaces and debris only
- Great for woodworking shops, household and garage smooth surfaces

Part No	Description	Qty/Pkg	Package
H454	14" Horsehair blend wood block counter brush	12	Label



HORSEHAIR BLEND BRUSH



- Natural horsehair and soft synthetic blended fiber
- Bristles pick up and sweep fine dust and debris on smooth surfaces
- Use on dry surfaces and debris only
- Great for woodworking shops, household and garage smooth surfaces

Part No	Description	Qty/Pkg	Package
750	14" Horsehair blend plastic block counter brush	12	Label



★ PREMIUM SOFT SYNTHETIC BRUSH



- Soft split-tip polystyrene fiber is safe on all surfaces
- Bristles pick up and sweep fine dust and debris on smooth surfaces and maintain shape
- Resilient synthetic bristles effective for dusting
- Good for woodworking shops, household and garage smooth surfaces

Part No	Description	Qty/Pkg	Package
457-1	14" Soft synthetic wood block counter brush	12	Label



SOFT SYNTHETIC BRUSH



- Soft split-tip fiber is safe on all surfaces
- Bristles pick up and sweep fine dust and debris on smooth surfaces
- Resilient synthetic bristles effective for dusting
- Good for shops, household and garage smooth surfaces

Part No	Description	Qty/Pkg	Package
733	14" Soft synthetic plastic block counter brush	12	Label



SOFT SYNTHETIC BRUSH AND SQUEEGE



- Split-tip fiber safe for all surfaces
- Bristles pick up and sweep fine dust and debris on smooth surfaces
- Rubber squeegee moves wet debris
- Easy grip handle
- Great dual use household tool

Part No	Description	Qty/Pkg	Package
740	14" Synthetic counter duster and squeegee	12	Label



★ PREMIUM DUAL SYNTHETIC BRUSH



- Dual stiff synthetic fibers
- Bristles dislodge dirt, debris and grime on all surfaces
- Durable bristles for everyday sweeping
- Good for janitorial and commercial cleaning applications

Part No	Description	Qty/Pkg	Package
471	14" Dual synthetic wood block counter brush	12	Label



ALL PURPOSE BRUSH



- Stiff synthetic fiber
- Bristles dislodge dirt, debris and grime on all surfaces
- Durable bristles for everyday sweeping
- Good for general cleanup of small to large debris

Part No	Description	Qty/Pkg	Package
736	14" All purpose plastic block counter brush	12	Label



TAMPICO BRUSH



- All-natural acid-resistant fiber
- Bristles resist acid, high heat and harsh chemicals
- Can be used for wet or dry applications
- Good for masonry pasting

Part No	Description	Qty/Pkg	Package
739	14" Tampico plastic block counter brush	12	Label



ENGINE BRUSHES



- Synthetic bristles remove sludge, grease, and dirt
- Bristles resistant to some chemicals, solutions, and acids
- Compact, slim profile for small, hard-to-reach areas
- Ideal for engines, tires, and vehicle parts cleaning

Part No	Description	Qty/Master Carton	Package
911	1/4" x 6-1/2" Compact engine brush, tin handle	12	Label
912	3/8" x 6-1/2" Compact engine brush, tin handle	12	Label
913	1/2" x 6-1/2" Compact engine brush, tin handle	12	Label
1004	1" x 11" Engine brush, wood handle	12	Label

- Nylon wire bristles remove sludge, grease, and dirt
- Super slim profile is ideal for tube and inner component cleaning
- Bristles curved along handle for 100% surface contact

Part No	Description	Qty/Master Carton	Package
992	12" Engine wire brush	36	Label

DETAIL BRUSHES



- Compact, slim profile for small, hard-to-reach areas
- Ideal for dashboards, seats, and tight spaces

Part No	Description	Qty/Master Carton	Package
997	7-1/2" Brass detail brush	36	Label
998	7-1/2" Nylon detail brush	36	Label
999	7-1/2" Stainless steel detail brush	36	Label

- Stiff bristles for heavy-duty scrubbing and cleaning
- Ideal for tires, floor mats, fenders and license plates

Part No	Description	Qty/Master Carton	Package
1940P	8-1/2" Multi-purpose stiff synthetic detail & scrub brush with comfort grip handle	12	Label
1940	8-1/2" Multi-purpose stiff synthetic detail & scrub brush	12	Label
1936	8-1/2" Multi-purpose brass detail & scrub brush	12	Label



CHIP BRUSHES



- 1-3/4" Trim synthetic bristles
- Compact profile for small, hard-to-reach areas
- Ideal for painting or applying heavy solvents, solutions, and cleaners

Part No	Description	Qty/Master Carton	Package
1006	1" Plastic chip brush	36	Label
1008	2" Plastic chip brush	24	Label

MISCELLANEOUS BRUSHES AND ITEMS

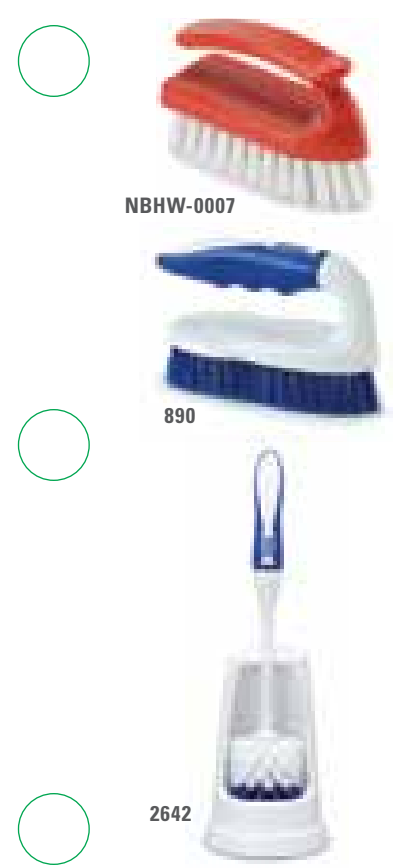

- Synthetic bristles for multi-purpose cleaning
- Raised plastic handle covers and protects hands while cleaning
- Ergonomic handle gives extra leverage when scrubbing
- Ideal for counters, washing machines, refrigerators and everyday cleaning

Part No	Description	Qty/Master Carton	Package
NBHW-0007	4" Raised handle multi-purpose brush	12	Label
890	6" Raised handle multi-purpose brush with comfort grip	12	Label

- Synthetic brush with comfort grip handle
- Small profile storage caddy

Part No	Description	Qty/Master Carton	Package
2642	Toilet bowl brush and caddy with comfort grip handle	12	Hang Tag

SWEEPING COMPOUND



- Apply using push broom for cleaner sweeping results
- Holds down dust and residue for faster sweeping
- Hard, clean and dry silica sand composite
- Red color is easy to see when cleaning
- Will not leave slippery residue
- Ideal for unfinished floors such as wood and concrete

Part No	Description	Qty/Master Carton	Package
70350	50 lb Red sweeping compound	1	Box



METAL DUSTPANS



- Heavy-duty, yet lightweight aluminum construction
- 9" rubber comfort-grip handle, easy to hang and store
- Grooved edges for brush cleaning
- Use indoors or outdoors on rough surfaces
- Ideal for job sites, construction clean-up, workshops, basements, garage floors, patios and sidewalks

Part No	Description	Qty/Master Carton	Package
H485	17" Heavy-duty aluminum dustpan	12	Label



- Solid steel construction
- 9" curved handle, easy to hang
- Grooved edges for brush cleaning
- Use indoors or outdoors on rough surfaces
- Ideal for job sites, construction, workshops, basements, garage floors, patios, and sidewalks

Part No	Description	Qty/Master Carton	Package
H495	17" Heavy-duty metal dustpan	12	Label



- Solid steel construction
- Large, easy-to-hold handle protects your knuckles
- Will retain liquid debris without leaking
- Use indoors or outdoors on rough surfaces
- Ideal for laundry rooms, workshops, basements, garage floors, patios and sidewalks

Part No	Description	Qty/Master Carton	Package
669	14" Shop Scoop™ Dustpan	6	Label



- Solid steel construction
- 5" handle, easy to hang and store
- Grooved edges for brush cleaning
- Use indoors or outdoors on smooth or rough surfaces
- Ideal for workshops, basements, garage floors, patios, sidewalks and decks

Part No	Description	Qty/Master Carton	Package
675	12" Metal dustpan	12	Label



LONG-HANDLE DEBRIS PANS



- Heavy-duty, durable plastic construction
- 24" curved handle with comfort grip
- Handle snap locks and releases for sweeping, dumping, and carrying debris
- Added clip for lobby brooms, hooks on standard cans and carts
- Use indoors or outdoors on smooth or rough surfaces
- Ideal for homes, garages, driveways, sidewalks, decks, patios and seasonal clean-up

Part No	Description	Qty/Master Carton	Package
497-1	14" Jumbo debris pan	10	Label
497-1P4	14" Jumbo debris pan	4	Label



- Heavy-duty, durable plastic construction
- 30" aluminum handle, easy to hang
- Handle snap locks and releases for sweeping, dumping, and carrying debris
- Added clip for lobby brooms, hooks on standard cans and carts
- Use indoors on smooth surfaces
- Ideal for homes, commercial shops, hotels, offices and theaters

Part No	Description	Qty/Master Carton	Package
478	13" Lobby debris pan	10	Label



PLASTIC DEBRIS PANS

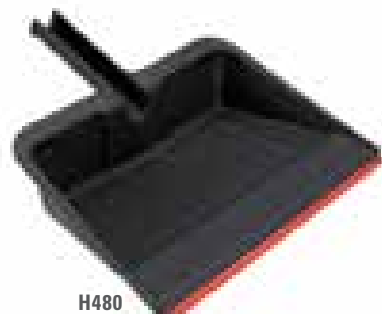

H480

- Reinforced, durable plastic construction
- 4" clip-on style handle attaches to most brooms
- Rubber lip keeps debris from being swept under dustpan
- Use indoors or outdoors on smooth surfaces
- Ideal for homes, garages, driveways, sidewalks, decks, patios and everyday use

Part No	Description	Qty/Master Carton	Package
H480	12" Black plastic dustpan w/ rubber lip	12	Label



480-7

- Reinforced, durable plastic construction
- 5" handle, easy to hang and store
- Grooved edges for brush cleaning
- Use indoors or outdoors on smooth surfaces
- Ideal for homes, garages, commercial shops and everyday use

Part No	Description	Qty/Master Carton	Package
480-7	12" Black plastic dustpan	12	Label



671

- Durable plastic construction
- 5" clip-on style handle attaches to most brooms, easy to hang and store
- Rubber lip keeps debris from being swept under dustpan
- Use indoors or outdoors on smooth or rough surfaces
- Ideal for homes, garages, commercial shops and everyday use

Part No	Description	Qty/Master Carton	Package
671	11" Black plastic dustpan with rubber lip	12	Label



10782P

- 9" plastic dustpan
- Handheld brush with 1-7/8" synthetic bristles
- Comfort grip handle locks in brush
- Compact design for tight, hard-to-reach spaces
- Use indoors on smooth surfaces
- Ideal for kitchens, bathrooms, laundry rooms, shops and pet hair clean-up

Part No	Description	Qty/Master Carton	Package
10782P	Brush and dustpan multi-purpose kit	24	Label



HANDLES

HARPER® offers an in-depth assortment of handles to match any broom, brush, squeegee or mop head in the HARPER family of cleaning tools. Whether it features bolt-on connectors, a threaded or tapered tip or a flow-thru design with water control valve, each handle is manufactured using the same superior-grade materials used for all HARPER cleaning tools — lacquered hardwood, powder-coated metal and heavy-duty fiberglass.

BEST-IN-CLASS BOLT-ON CONNECTORS



85HP

- Heavy-duty metal connector
- Bolt-on connector provides tight, secure connection
- Use with best-in-class red-end push brooms

Part No	Description	Qty/Master Carton	Package
85HP	1-1/8" x 60" Lacquered wood handle	12	Label

THREADED METAL TIP



562

551

- Heavy-duty replacement handles
- Durable, threaded metal tip

Part No	Description	Qty/Master Carton	Package
91248H	15/16" x 48" Lacquered wood handle	12	Label
91254H	15/16" x 54" Lacquered wood handle	12	Label
562	15/16" x 60" Lacquered wood handle	12	Label
558	15/16" x 72" Lacquered wood handle	12	Label
551	1-1/8" x 60" Lacquered wood handle	6	Label
90272H	1-1/8" x 72" Lacquered wood handle	12	Label
90296H	1-1/8" x 96" Lacquered wood handle	6	Label

THREADED WOOD TIP

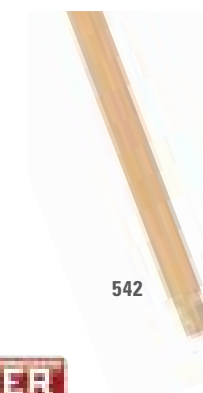

542

Part No	Description	Qty/Master Carton	Package
536	7/8" x 48" Sanded wood handle	50	Label
90054H	15/16" x 54" Lacquered wood handle	12	Label
542	15/16" x 60" Lacquered wood handle	12	Label



THREADED PLASTIC TIP



- Heavy-duty replacement handles
- Reinforced, durable threaded plastic tip
- Tip resists some acids and cleaning chemicals

Part No	Description	Qty/Master Carton	Package
90148H	15/16" x 48" Lacquered wood handle, hang-up storage cap	12	Label
90154H	15/16" x 54" Lacquered wood handle	12	Label
90160H	15/16" x 60" Lacquered wood handle	12	Label
90460H	1-1/8" x 60" Lacquered wood handle	12	Label
90472H	1-1/8" x 72" Lacquered wood handle	12	Label
90496H	1-1/8" x 96" Lacquered wood handle	6	Label



- Thick coated metal resists scratching and cracking
- Reinforced, durable threaded plastic tip

Part No	Description	Qty/Master Carton	Package
540	7/8" x 48" Powder coated metal handle	25	Label
116H	7/8" x 48" Red powder coated metal handle, hang-up storage cap	12	Label
11754H-7	15/16" x 54" Powder coated metal handle	12	Label
563	15/16" x 60" Powder coated metal handle, hang-up storage cap	24	Label

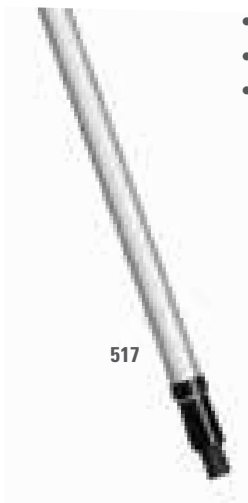

- Reinforced, durable threaded plastic tip
- Strong, lightweight aluminum construction
- Extends for hard-to-reach areas, retracts for tight space cleaning

Part No	Description	Qty/Master Carton	Package
517	27" - 48" Telescoping aluminum handle	20	Label



TAPERED HANDLES



- Heavy-duty replacement handles
- Pair with steel brace for extra reinforcement

Part No	Description	Qty/Master Carton	Package
549	15/16" x 54" Lacquered wood handle	12	Label
550	1-1/8" x 54" Lacquered wood handle	12	Label
552	1-1/8" x 60" Lacquered wood handle	12	Label
555	1-1/8" x 72" Lacquered wood handle	12	Label

UNBREAKABLE HANDLES



- Lacquered wood
- Unbreakable connector will not warp, bend or break
- Absorbs shock and allows for quicker and easier cleaning
- Padded grip
- Hardware included

Part No	Description	Qty/Master Carton	Package
557	1-1/8" x 60" Wood handle with unbreakable connector	12	Label

SQUEEGEE HANDLES



- Lacquered wood
- Durable, reinforced plastic connector
- Angled for straight and curved floor squeegees

Part No	Description	Qty/Master Carton	Package
248243H	1-1/8" x 60" Dual-use squeegee handle	6	Label

- Lacquered wood
- For straight floor squeegees

Part No	Description	Qty/Master Carton	Package
248HAS	1-1/8" x 60" Squeegee handle	12	Label



WET MOP HANDLES



495

- Lacquered wood
- Metal quick-change hardware for easy swapping out of mop heads

Part No	Description	Qty/Master Carton	Package
495	1-1/8" x 60" Wood mop handle, metal quick clip	6	Label



6717

- Thick coated metal resists scratching and cracking
- Reinforced, durable plastic quick-change hardware

Part No	Description	Qty/Master Carton	Package
6717	15/16" x 60" Powder coated metal mop handle, plastic quick clip	12	Label

DUST MOP HANDLES



40660H

- Lacquered wood
- Quick-release connector for fast swapping out metal dust mop frames
- Metal connector swivels for easy use

Part No	Description	Qty/Master Carton	Package
40660H	1-1/8" x 60" Wood mop handle, quick release connector	12	Label



FLOW-THRU HANDLES



504

514

- Reinforced, durable threaded tip
- Easy-turn knob for quick water flow control
- Telescoping handles extend for hard-to-reach areas and retract for cleaning tight spaces
- Ideal for window, wall, and car washing
- Pairs with all HARPER wash brush heads

Part No	Description	Qty/Master Carton	Package
504	60" Steel flow-thru handle with on/off water control valve	6	Label
511	37"-64" Telescoping flow-thru handle with on/off water control valve and dual comfort grip	10	Label
514	39"-66" Telescoping flow-thru handle with on/off water control valve and dual comfort grip	10	Label

HEAVY-DUTY FIBERGLASS

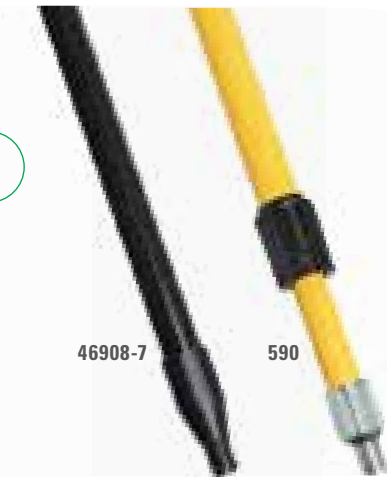

46908-7

590

- Super strong and lightweight fiberglass construction
- Reinforced, durable threaded tip
- Telescoping handles extend for hard-to-reach areas and retract for tight space cleaning

Part No	Description	Qty/Master Carton	Package
46908-7	1" x 60" Heavy-duty fiberglass handle with threaded plastic tip	12	Label
590	48"-96" Telescoping heavy-duty fiberglass handle with threaded metal tip	6	Label
591	72"-144" Telescoping heavy-duty fiberglass handle with threaded metal tip	6	Label



PUSH BROOM STEEL BRACES



- Heavy-duty powder-coated metal
- All hardware included, braces ship unassembled (except H86)
- Durable replacement parts for HARPER push brooms

Part No	Description	Qty/Master Carton	Package
H86	16" Push broom steel brace (assembled)	12	MC Box
H87	18" – 36" Push broom premium steel brace	50	Bag/Label
52195	18" – 36" Push broom steel brace	50	Bag/Label
H89	42" Push broom steel brace	12	Bag/Label
561	Push broom clamp brace, light duty for threaded handles	12	Bag/Label

SQUEEGEE STEEL BRACES



- Heavy-duty powder-coated metal
- All hardware included, braces ship unassembled
- PowrWave® uses #H81

Part No	Description	Qty/Master Carton	Package
81-253	Squeegee steel brace for 25322 and 25330	12	Bag/Label
H81	18" – 36" Squeegee steel brace	12	Bag/Label

WASH BRUSH STEEL BRACES



- Works with 8", 10" and 14" Wash Brushes
- Heavy-duty powder-coated metal
- All hardware included, braces ship unassembled

Part No	Description	Qty/Master Carton	Package
86-88	Wash brush steel brace	12	Bag/Label



CONNECTORS



- For use with HARPER slotted blocks
- Reinforced steel construction

Part No	Description	Qty/Master Carton	Package
84D	HARPER Heavy-duty push broom connector	12	MC Box

HANDLE REPLACEMENT TIPS



- Fits 15/16" wood handles
- For use with threaded plastic or threaded wood blocks

Part No	Description	Qty/Master Carton	Package
901T	Threaded plastic replacement tip	12	MC Box
912T	Threaded metal replacement tip	12	MC Box
915T	Threaded zinc replacement tip, fits fiberglass handles	12	MC Box

SQUEEGEE CONNECTORS



- Reinforces handle to squeegee head
- Use with HARPER straight and curved floor squeegees
- For PowrWave® use 240 or H241

Part No	Description	Qty/Master Carton	Package
240	Metal straight floor squeegee connector	12	MC Box
240-45	Metal alloy curved floor squeegee connector	40	MC Box
H241	Reinforced plastic straight floor squeegee connector	12	MC Box
H243	Reinforced plastic straight & curved floor squeegee connector	12	MC Box



MERCHANDISERS

HARPER® offers a variety of product merchandisers and planograms for all corners of your store. Our free-standing displays are easy to setup, move around, and have plenty of holding power. Contact your Salesperson for a custom product assortment specifically designed for your store.

FREE-STANDING DISPLAYS



FRONT BACK
DSPLY06

- Heavy-duty metal construction
- Includes 8 double broom hooks, 12 single hooks, 4 dust pan trays, and HARPER graphic panels
- Easy to move and relocate at retail
- Easy to assemble, instructions included
- Pre-selected and custom assortments available (product sold separate)

Part No	Description	Assembled Dimensons (L x W x H)
DSPLY06	Walk-around multi-tool display	36" x 36" x 108"



Push broom display

- Heavy-duty one-piece metal construction
- 12 spaces to hold assembled push brooms and squeegees
- Easy to move and relocate at retail, opportunity for seasonal product updates
- Enhanced design with metal band for UPC and price labels
- HARPER graphic panel included
- Pre-selected and custom assortments available (product sold separate)

Part No	Description	Assembled Dimensons (L x W x H)
DSPLY03	Harper Branded Push Broom Display	22-1/2" x 31" x 24.5"



PRODUCT HOOKS AND DISPLAYERS



- Durable, strong product pegs and merchandisers
- Clean black finish
- Fits into Lozier fixture

Part No	Description	Qty/Master Carton	Package
11002	4" Wash brush hook	10	Box
D5-15	15" Single prong hook with scanner plate	100	Box
D5-13	15" Double prong hook	10	Box
D5-14	15" Handle guide with scanner plate, use with D5-13	10	Box
11001	18" Double prong broom holder	10	Box
11013	18" Metal handle display with HARPER graphic	1	Box
002695	HARPER hook tags	45	Box
12974	48" HARPER header display, incudes graphic	1	Box



Contact your Salesperson for custom tailored planograms for your store!



PART NO.	PAGE	PART NO.	PAGE	PART NO.	PAGE	PART NO.	PAGE	PART NO.	PAGE	PART NO.	PAGE	PART NO.	PAGE
81-253	74	454	26	852	60	1426ASC	14	7318A	10	40601A	53	583236	23
84D	75	454A	26	854	60	1426P1	14	7324	10	40624	53	587918	24
85HP	69	466	33	875	57	1426P12	14	7324A	10	40624F	53	587918SC	24
86-88	74	469	32	876	57	1434	15	7324P1	10	40636	53	587924	24
105-1	36	474	33	877	57	1434A	15	7330	10	40636F	53	587924SC	24
108-1	36	475	35	882	57	1434AJ	19	7918A	11	40660H	72	587936	24
109	37	476	34	886	55	1434ASC	15	7924	11	46908-7	73	589624	26
109A	37	477ND	35	887	55	1434ASQ	19	7924A	11	52195	74	589624A	26
110	37	478	67	890	65	1434P1	15	7924AS	11	70350	65	685508	39
111	37	479	49	896	57	1434P12	15	7924P1	11	90054H	69	685510	39
112	37	480	49	897	57	1435	16	8150	39	90148H	70	686508X	42
115-4	36	480-7	68	900	57	1435A	16	8151	40	90154H	70	686510X	42
115-4A	36	482	48	901	57	1435AJ	20	8382	60	90160H	70	686614	39
116H	70	483	48	901T	75	1435ASC	16	8472	59	90272H	69	731812	10
117	37	484	48	902	57	1435P1	16	8482	60	90296H	69	732412	10
118-4	36	485	48	906A	56	1435P12	16	8572	59	90460H	70	791812	11
157-14	56	485A	48	907	56	1436P12	16, 20	9418	12	90472H	70	792412	11
200	24	486	49	908	56	1437A	16	9418A	12	90496H	70	885510	39
201	24	487	49	909	56	1451	41	9424	12	91248H	69	886510	42
203	24	488	49	911	64	1508	39	9424A	12	91254H	69	887310	40
213	24	489	48	912	64	1510	40	9424AS	12	142112	13	887310A	41
213A	15	490	48	912T	75	1512	40	9616	12	142212	14	897510	42
214	24	495	72	913	64	1524	42	9618	12	142312	15	941812	12
214A	15	497-1	67	914	56	1524A-1	28	9816A	26	142512	13, 17	942412	12
214AJ	18	497-1P4	67	915	56	1525SC	28	10516A-1	36	142612	14, 17	1524224A	45
214SC	15	504	73	915T	75	1936	64	10779	33	143412	15, 19	5324224A	45
221	59	511	73	918	55	1940	64	10782P	68	143512	16, 20	5324224PI	45
224	59	514	73	918AF	55	1940P	64	10804A	36	143612	16, 20	53561912A	55
231	59	517	70	918AFS	55	2218A	7	11001	77	143712	16	D5-13	77
234	59	530	33	941	57	2224	7	11002	77	143812	14	D5-14	77
240	75	536	69	942	57	2224A	7	11013	77	143912	14	D5-15	77
240-45	75	540	70	945	57	2224P1	7	11021L	41	160201-2	49	DSPLY03	76
247	25	542	69	946	57	2236	7	11202A	37	221812	7	DSPLY06	76
248HAS	71	549	71	992	64	2642	65	11715	41	222412	7	H81	74
255	25	549CC	57	997	64	002695	77	11754H-7	70	223612	7	H86	74
256	25	550	71	998	64	2718	40	12712	41	248243H	47, 71	H87	74
257	28	551	69	999	64	2724	40	12717	41	302412	9	H89	74
258	27	552	71	1004	64	3024A	9	12973	41	322412	8	H100	32
259	27	555	71	1006	65	3224	8	12974	77	323612	8	H241	75
260	28	557	71	1008	65	3224A	8	14081	41	341812	9	H243	75
260A	28	558	69	1038	56	3236	8	14083	41	342412	9	H268	50
261	29	561	74	1055	43	3418	9	15168	41	343612	9	H281	59
264	29	562	69	1100	39	3418A	9	20508	51	471012	37	H303	52
267	29	563	70	1101	39	3424	9	20710	51	542412	8	H356	43
278A	25	567	46	1102	40	3424A	9	24224	45	567552	46	H454	61
291	59	569	46	1103	40	3424P1	9	24724	47	567552A	46	H480	68
297	29	570	46	1125	42	3430A	9	24730	47	574552A	45	H485	66
303R	52	571	46	1200	39	3436	9	24824R	47	581918-1	21	H495	66
304	29	590	73	1201	39	4042	35	24830R	47	581924-1	21	H2218	7
305	29	591	73	1299	40	4045L	35	24836R	47	582218	22	H3024	9
308	52	642	51	1421A	13	4047	34	25018	46	582218SC	22	H3430	9
308R	52	648	51	1422A	14	4048	34	25322	46	582224	22	H7336	10
347	21	650	51	1423A	15	5424	8	25322A	45	582224SC	22	H7918	11
348	21	669	66	1425	13	5424A	8	25330	46	582236	22	H24736	47
405	25	671	68	1425A	13	6717	72	25524	47	583118	23	H24824	47
408	25	675	66	1425AJ	17	6724A	10	25524R	47	583118SC	23	H24830	47
409	25	736	63	1425P1	13	6724P1	10	25530	47	583124	23	H24836	47
410	25	739	63	1425P12	13	7020	32	25530R	47	583124A-1	23	NBHW-0007	65
426-18	56	750	61	1426	14	7030	50	25536	47	583124SC	23	NBID-0006	55
451	26	849	60	1426A	14	7031	50	25536R	47	583218	23		
453	61	851	60	1426AJ	17	7318	10	25636	47	583224	23		

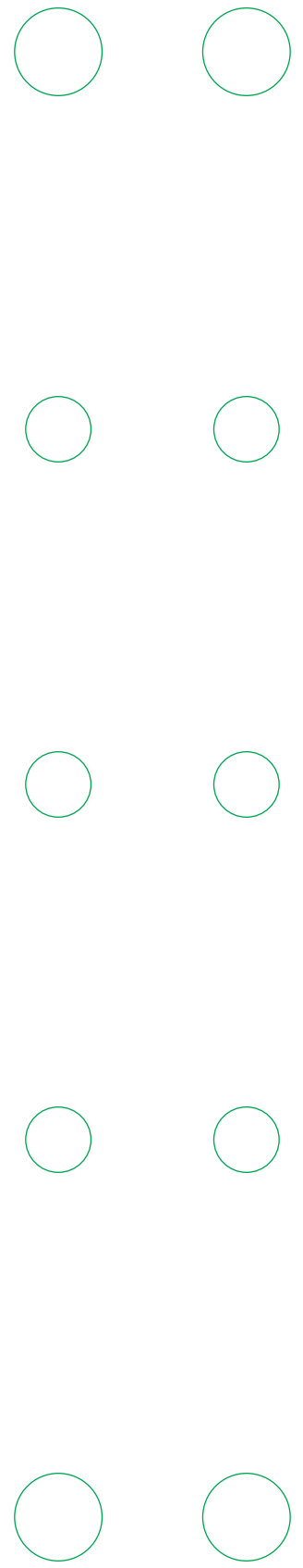

HARPER

Est. 1900

800.393.1846
WWW.HARPERBRUSH.COM



©2018
The AMES Companies, Inc.
465 Railroad Avenue
Camp Hill, PA 17011
1.800.393.1846